



Dental Instruments

CONTENTS

INHALT

EXTRACTION

Extracting Forceps.....	05
Ronguer Forceps.....	25
Elevators.....	29

EXTRAKTION

Zahnzangen
Hohlmeißelzangen
Wurzelheber

SURGERY

Scalpels.....	45
Scissors.....	48
Dissecting Forceps.....	56
Haemostatic Forceps.....	60
Bone Curettes / Periosteal Elevators.....	62
Chisels / Mallets.....	70
Implantology.....	76
Retractors / Mouth Gags.....	81
Needle Holders.....	87
Accessories.....	91

CHIRURGIE

Skalpelle
Scheren
Pinzetten
Klemmen
Scharfe Löffel / Raspatorien
Meißel / Hämmer
Implantologie
Wund- / Wangen- / Zungenhalter
Nadelhalter
Zubehör

DIAGNOSIS

Mouth Mirrors.....	96
Tweezers.....	98
Explorers / Perio Probes.....	102

DIAGNOSTIK

Mundspiegel
Pinzetten
Zahnsonden / PA-Sonden

PERIODONTIA

Scalers.....	110
Curettes.....	115
Gingivectomy.....	125

PARODONTOLOGIE

Scaler
Küretten
Gingivektomie

CONSERVATIVE DENTISTRY

Enamel Chisels / Gingival Margin Trimmers.....	130
Excavators.....	132
Matrix Retainers and Matrixes.....	137
Amalgam Carriers.....	138
Filling Instruments.....	140
Composite Instruments.....	149
Carving Instruments.....	151
Cement Spatula.....	159
Rubber Dam Instruments.....	160
Endodontia.....	162

KONSERVIERENDE BEHANDLUNG

Schmelzmeißel / Gingivalrandschräger
Exkavatoren
Matrizenspanner und Matrizen
Amalgampistolen
Füllungsinstrumente
Composite Instrumente
Modellierinstrumente
Zementspatel
Kofferdaminstrumente
Endodontie

PROSTHODONTIA/ ORTHODONTIA

Carving Instruments.....	168
Knives / Spatula.....	172
Crown Instruments.....	176
Impression Trays.....	184
Pliers.....	192

PROTHETIK/ ORTHODONTIE

Modellierinstrumente
Messer / Spatel
Kroneninstrumente
Abdrucköffel
Zangen

Alphabetical Index.....	208
-------------------------	-----

Alphabetischer Index

Numerical Index.....	224
----------------------	-----

Numerischer Index

CONTENU

CONTENIDO

EXTRACTION

Daviers.....	05	Forceps
Pincès Gouges.....	25	Pinzas Gubias
Elévateurs.....	29	Botadores

EXTRACCIÓN

Forceps
Pinzas Gubias
Botadores

CHIRURGIE

Bistouris.....	45	Bisturios
Ciseaux.....	48	Tijeras
Pincès à Dissection.....	56	Pinzas de Discción
Pincès Hémostatiques.....	60	Pinzas Hemostáticas
Curettes Osseuses / Rugines.....	62	Curetas Óseas / Periostotomos
Burins / Gouges / Maillets.....	70	Cinceles / Martillos
Implantologie.....	76	Implantología
Ecarteurs / Ouvre-Bouches.....	81	Separadores / Abre-Bocas
Porte-Aiguilles.....	87	Porta-Agujas
Accessoires.....	91	Accesorios

CIRUGÍA

Bisturios
Tijeras
Pinzas de Discción
Pinzas Hemostáticas
Curetas Óseas / Periostotomos
Cinceles / Martillos
Implantología
Separadores / Abre-Bocas
Porta-Agujas
Accesorios

DIAGNOSTIC

Miroirs à Bouche.....	96	Espejos de Boca
Précèlles.....	98	Pinzas
Sondes.....	102	Sondas

DIAGNÓSTICO

Espejos de Boca
Pinzas
Sondas

PARODONTOLOGIE

Instruments à Détrarrter.....	110	Limpiadores de Sarro
Curettes.....	115	Curetas
Gingivectomie.....	125	Gingivectomia

PERIODONCIA

Limpiadores de Sarro
Curetas
Gingivectomia

DENTISTERIE CONSERVATRICE

Ciseaux à Email / Finisseurs à Bords Gingivaux.....	130	Cinceles para Esmalte / Recortadores del Margen Gingival
Excavateurs.....	132	Excavadores
Porte-Matrices et Matrices.....	137	Portamatrices y Matrices
Porte-Amalgames.....	138	Porta Amalgamas
Instruments pour Obturations.....	140	Instrumentos para Obturacines
Instruments pour Composite.....	149	Instrumentos para Composite
Instruments à Modeler.....	151	Instrumentos para Modelar
Spatulas à Ciment.....	159	Espátulas para Cemento
Instruments pour Digue de Caoutchouc.....	160	Instrumentos para Dique de Goma
Endodontie.....	162	Endodoncia

ODONTOLOGÍA DE CONSERVACIÓN

Cinceles para Esmalte / Recortadores del Margen Gingival
Excavadores
Portamatrices y Matrices
Porta Amalgamas
Instrumentos para Obturacines
Instrumentos para Composite
Instrumentos para Modelar
Espátulas para Cemento
Instrumentos para Dique de Goma
Endodoncia

PROTHÈSE / ORTHODONTIE

Instruments à Modeler.....	168	Instrumentos para Modelar
Couteaux / Spatulas.....	172	Cuchillos / Espátulas
Instruments à Couronnes.....	176	Instrumentos para Coronas
Porte-Empreintes.....	184	Cubetas de Impresiones
Pincès.....	192	Pinzas

PROSTODONCIA / ORTODONCIA

Instrumentos para Modelar
Cuchillos / Espátulas
Instrumentos para Coronas
Cubetas de Impresiones
Pinzas

Index Alphabetique.....	208	Índice Alfabético
-------------------------	-----	-------------------

Index Numérique.....	224	Índice Numérico
----------------------	-----	-----------------



36

EXTRACTION
EXTRAKTION
EXTRACTION
EXTRACCIÓN

Karogriff
 Handle with diamond profile
 Manche à carreaux
 Mango con forma de diamante

36

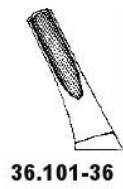
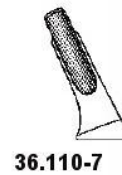
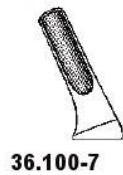
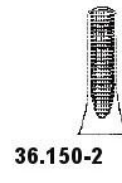
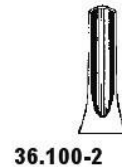
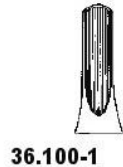

Karogriff
 Handle with diamond profile
 Manche à carreaux
 Mango con forma de diamante

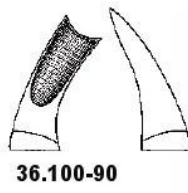
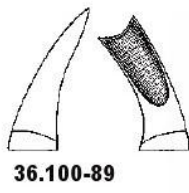
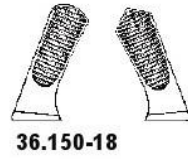
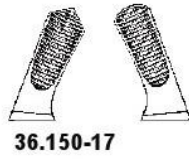
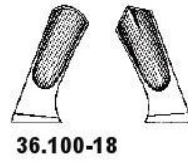
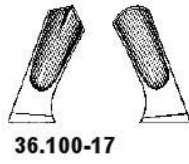

36

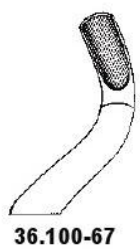

Karogriff
 Handle with diamond profile
 Manche à carreaux
 Mango con forma de diamante

36

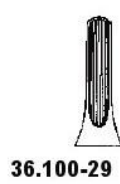

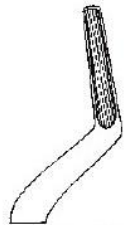

36.100-51

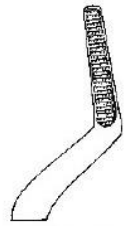

36.150-51



Wurzeln · roots
racines · raíces



36.100-51F



Wurzeln · roots
racines · raíces

Karogriff
Handle with diamond profile
Manche à carreaux
Mango con forma de diamante



36



36.100-51A



36.150-51A



Wurzeln · roots
racines · raíces



36.100-51C



Wurzeln · roots
racines · raíces

Karogriff
 Handle with diamond profile
 Manche à carreaux
 Mango con forma de diamante



36



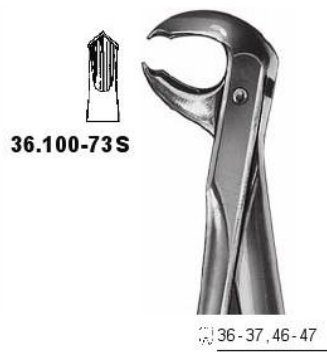

Karogriff
 Handle with diamond profile
 Manche à carreaux
 Mango con forma de diamante



36



Karogriff
 Handle with diamond profile
 Manche à carreaux
 Mango con forma de diamante



36.100-21



36-37, 46-47



36.100-87

36-37, 46-47

36



36.100-79



38, 48



36.100-79A



38, 48



36.150-79



38, 48



36.228L

Routurier



38



36.228R

Routurier



48



Karogriff
Handle with diamond profile
Manche à carreaux
Mango con forma de diamante

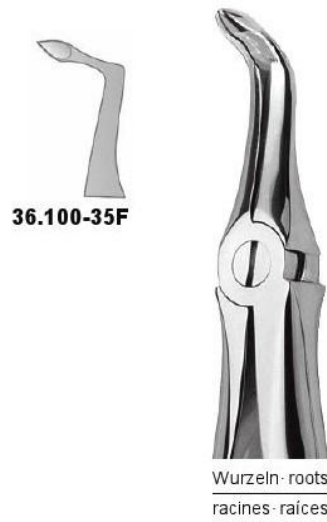

36

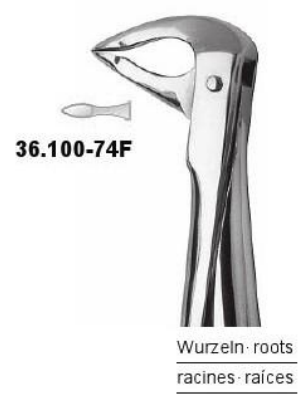

Anatomischer Griff
 Anatomic handle
 Manche anatomique
 Mango anatómico



diamantiert, diamond coating, couche de diamant, capa de diamante

36

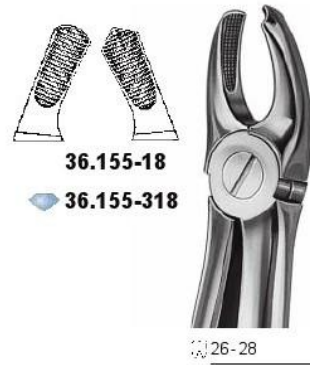
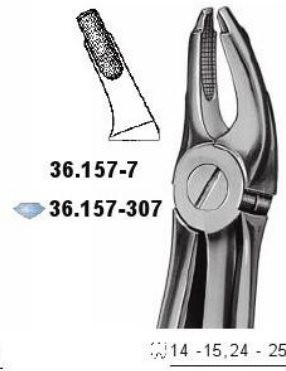
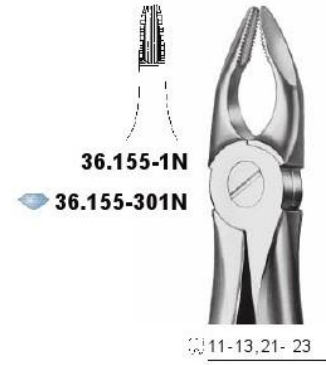
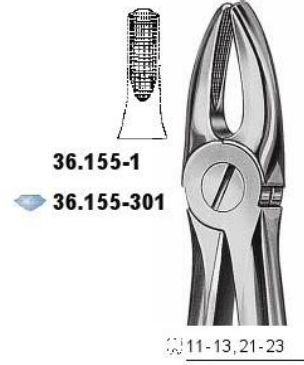

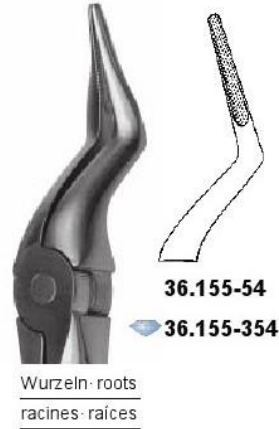
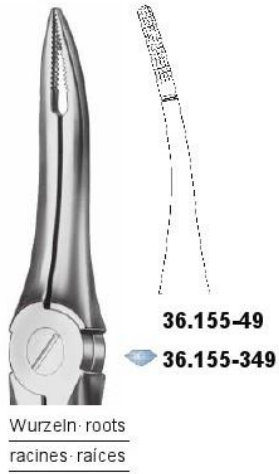

Anatomischer Griff
 Anatomic handle
 Manche anatomique
 Mango anatómico



diamantiert, diamond coating, couche de diamant, capa de diamante

36



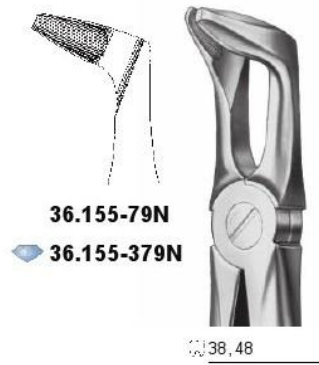



diamantiert, diamond coating, couche de diamant, capa de diamante

36

36.171 STIEGLITZ
 Wurzelfragmente
 Root fragments
 Fragments de racines
 Fragmentos de raíces

36.175
 Wurzelfragmente
 Root fragments
 Fragments de racines
 Fragmentos de raíces



36.166 WITZEL
 ♦ **36.166-300 WITZEL**
 obere Wurzeln
 upper roots
 racines supérieures
 raíces superiores

36.169
 obere Wurzeln
 upper roots
 racines supérieures
 raíces superiores

36.164 WITZEL
 ♦ **36.164-300 WITZEL**
 untere Wurzeln
 lower roots
 racines inférieures
 raíces inferiores

36.168
 untere Wurzeln
 lower roots
 racines inférieures
 raíces inferiores

Kinder
Children
Enfants
Niños

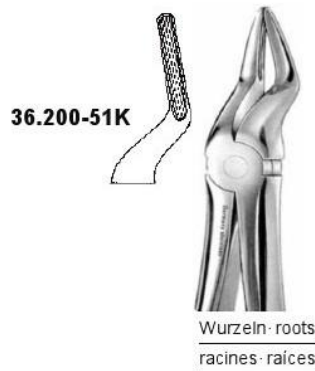
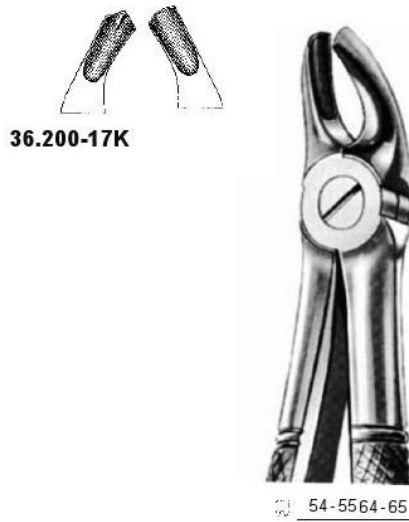

36

Kinder
Children
Enfants
Niños



Kinder
Children
Enfants
Niños

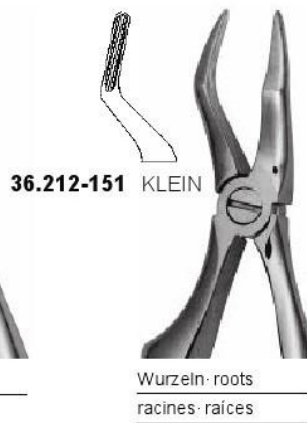
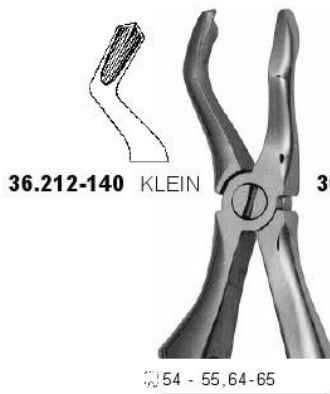

36



Amerikanische Form
 American pattern
 Modèle américain
 Modelo americano

36



Amerikanische Form
 American pattern
 Modèle américain
 Modelo americano

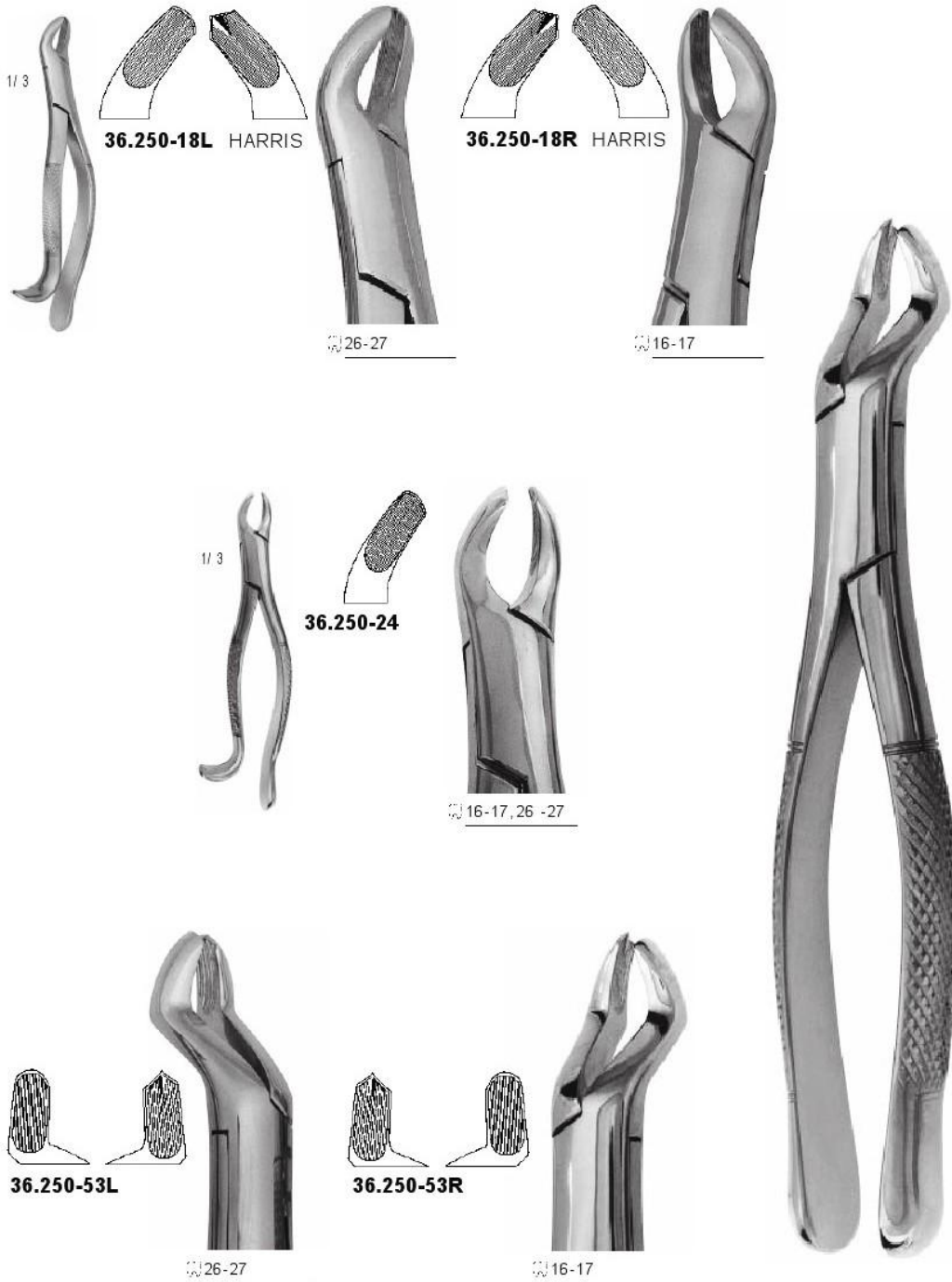

36

Amerikanische Form
 American pattern
 Modèle américain
 Modelo americano

36



Amerikanische Form
American pattern
Modèle américain
Modelo americano



Hohlmeisselzangen
Rongeur forceps
Pincers gouges
Pinzas gubias

36



36.431-20 MINI-FRIEDMANN
15,5 cm



36.431-21 MINI-FRIEDMANN
15 cm, S - Form



36.431-10 MINI-FRIEDMANN
14,5 cm



36.431 FRIEDMANN
14 cm

Hohlmeisselzangen
Rongeur forceps
Pincers gouges
Pinzas gubias



Hohlmeisselzangen
Rongeur forceps
Pinces gouges
Pinzas gubias

36



36.441 FIG. 3
14,5 cm

36.451 BLUMENTHAL
45°, 14,5 cm



36.514 FIG. 5
16,5 cm

Hohlmeisselzangen
Rongeur forceps
Pinces gouges
Pinzas gubias



36.500 BÖHLER
16,5 cm



36.503 BEYER
18 cm

36

- ▶ Sehr graziler Wurzelheber für feinfühliges Arbeiten
- ▶ Very delicate elevator for gentle working
- ▶ Elévateur très gracile pour un travail délicat
- ▶ Elevador muy grácil para un trabajo suave

36

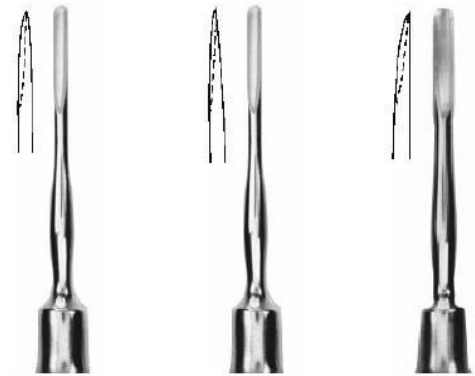

36.610-2 LUXATOR	36.610-3 LUXATOR	36.610-4 LUXATOR
2,5 mm, sehr fein	3,5 mm, sehr fein	4,5 mm, sehr fein
2,5 mm, very delicate	3,5 mm, very delicate	4,5 mm, very delicate
2,5 mm, très gracile	3,5 mm, très gracile	4,5 mm, très gracile
2,5 mm, muy grácil	3,5 mm, muy grácil	4,5 mm, muy grácil

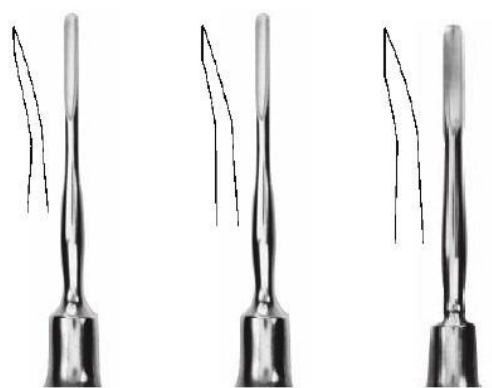

36.610-12 LUXATOR	36.610-13 LUXATOR	36.610-14 LUXATOR
2,5 mm, sehr fein	3,5 mm, sehr fein	4,5 mm, sehr fein
2,5 mm, very delicate	3,5 mm, very delicate	4,5 mm, very delicate
2,5 mm, très gracile	3,5 mm, très gracile	4,5 mm, très gracile
2,5 mm, muy grácil	3,5 mm, muy grácil	4,5 mm, muy grácil

gerade
straight
droit
recto

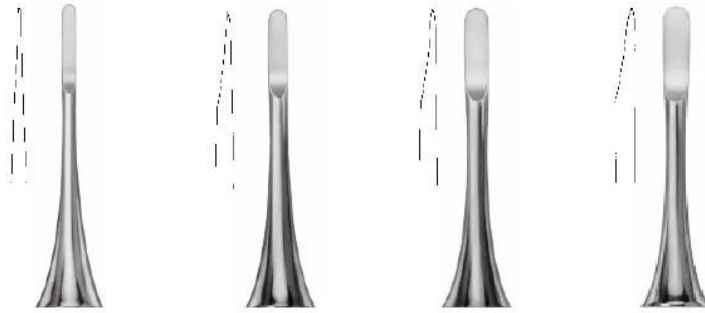

36.614-2 LUXATOR
2 mm

36.614-3 LUXATOR
3 mm

36.614-4 LUXATOR
4 mm

36.614-5 LUXATOR
5 mm

gebogen
curved
courbé
curva

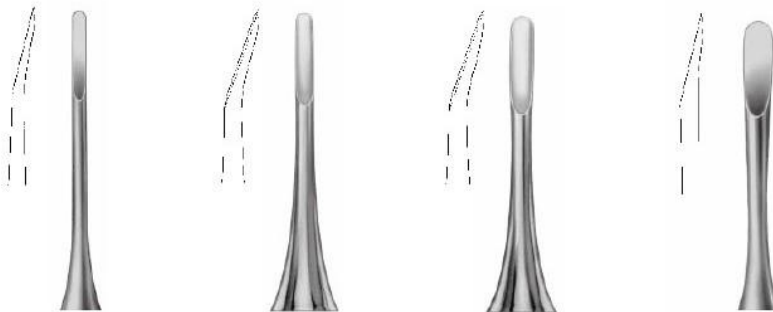

36.614-12 LUXATOR
2 mm

36.614-13 LUXATOR
3 mm

36.614-14 LUXATOR
4 mm

36.614-15 LUXATOR
5 mm



36

36



36.620-23 BEIN 3 mm
36.620-2 BEIN 2 mm
36.620-3 BEIN 3 mm
36.620-4 BEIN 4 mm



36.634-4 FIG. 301 2,5 mm
36.634-3 FIG. 46 3 mm
36.634-2 FIG. 34S 4 mm
36.634-1 FIG. 34 5 mm



36.636-1



36.636-2



36.636-3



36.636-4

36



36.636-5



36.636-6

36



36.646-1 COUPLAND
3 mm



36.646-2 COUPLAND
3,8 mm



36.646-3 COUPLAND
4,6 mm



36.640-1 HYLIN



36.640-2 HYLIN



36.642 FIG. 3



36



36.1490-1 CHOMPRET
Syndesmotome
Syndesmotomes
Sindesmotomes
Sindesmotomos



36.1490-2



36.1490-3



36.1491-2 massiv
Syndesmotome
Syndesmotomes
Sindesmotomes
Sindesmotomos



36.1491-12 SYNDESMOTOME
fein gezahnt, massiv
fine serrated, massive
denté fin, massif
dentado fino, masivo



36

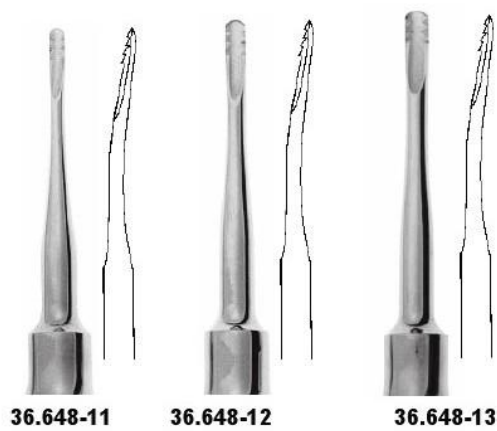

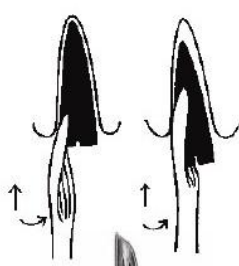

36.710-1 KOPP



36.710-2 KOPP



36.710-3 KOPP



36.710-4 KOPP

36



KOPP



KOPP



36.710-11 KOPP



36.710-12 KOPP



36.710-13 KOPP



36.710-14 KOPP



36.723 COLEMAN



36.726-1 LONDON HOS PITAL 36.726-2



36.804-1 WARWICK-JAMES



36.804-2 WARWICK-JAMES 36.804-3



36.838-1 SELDIN **36.838-2 SELDIN**
④6+7, Fig. 1L ④6+7, Fig. 1R

36



36.830-1 CRYER



36.830-2 CRYER



36.835-1 CRYER



36.835-2 CRYER



36.836-27 CRYER



36.836-28 CRYER



36



Krallenheber
Claw elevators
Elévateurs à griffes
Elevadores de garra



36.920-2 POTT



36



36.760-2



36.760-1

für Molaren-Wurzeln
for molar roots
pour racines de molaires
para raíces de molares



36.920-1 POTT

nur für Wurzelfragmente
for root fragments only
seulement pour des fragments
solamente para fragmentos



36

Drehmeissel
Chisels
Ciseaux-burins
Cinceles

gerade / straight / droit / recto / retto, 13 cm

36.925-2 2 mm

36.925-3 3 mm

36.925-4 4 mm



bajonett / bayonet / baïonnette / bayoneta / baionetta, 13 cm

36.926-2 2 mm

36.926-3 3 mm

36.926-4 4 mm



36

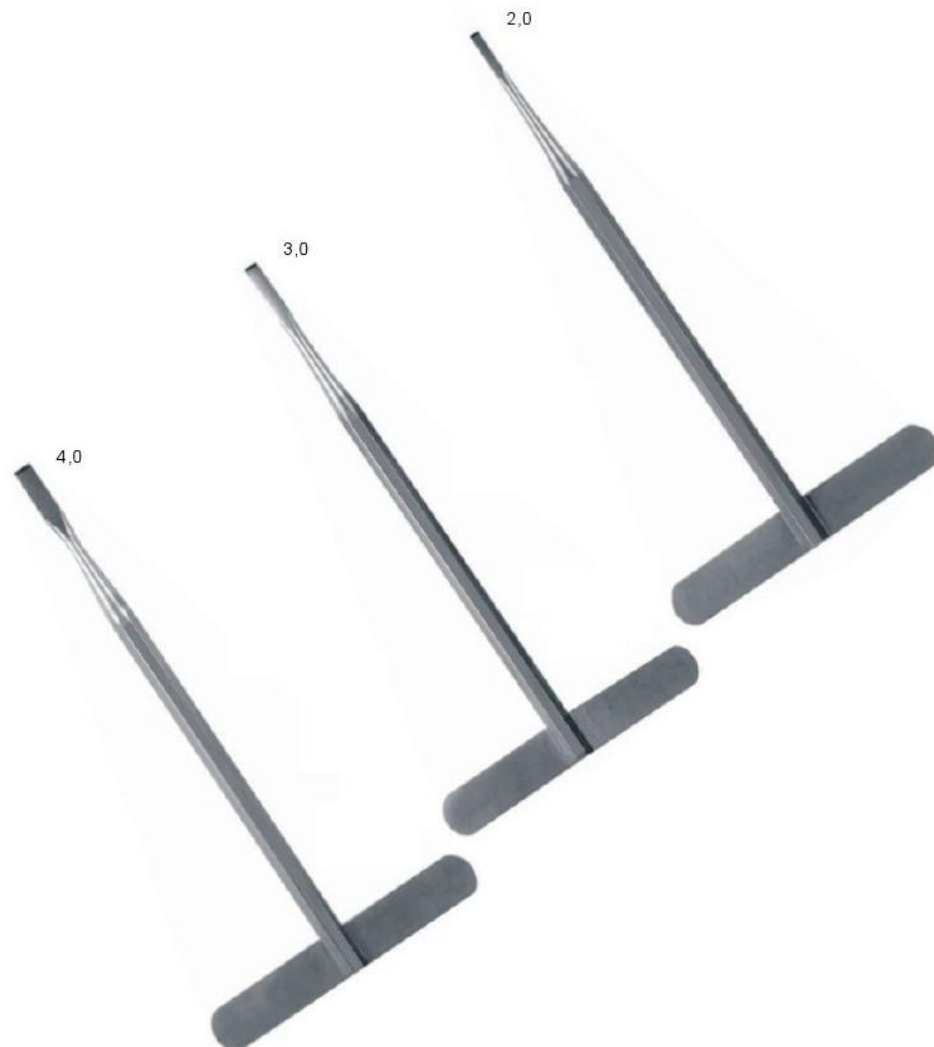



37

SURGERY
CHIRURGIE
CHIRURGIE
CIRUGÍA

37.1070-61 - 69

Mini-Klingen steril / P. zu 10 Stück
 Mini blades sterile / P. of 10 pieces
 Mini lames stérile / P. de 10 pièces
 Mini hojas estériles / P. de 10 piezas

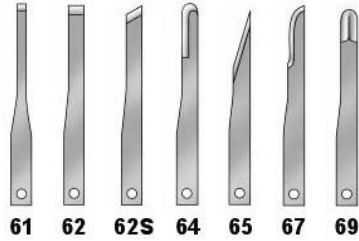

37.1071-10 10 cm

37.1071-13 13 cm

37.1071-15 15 cm

Halter für Mini-Klingen
 Holder for Mini blades
 Manche pour Mini lames
 Mango para Mini hojas

37

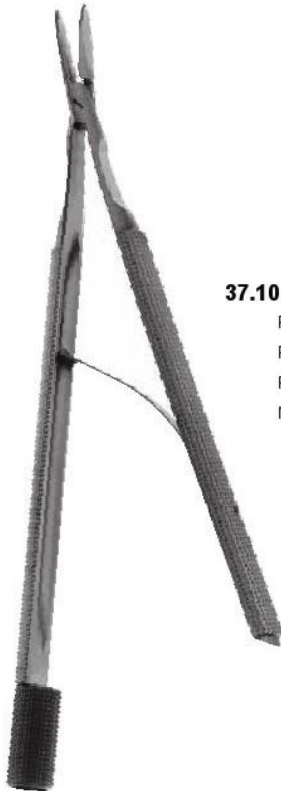

37.1035

Rasierklingshalter
 Razor blade holder
 Porte lames à rasoir
 Mango para hojas de afeitarse

Skalpellklingen
Scalpel blades
Lames de bistouris
Hojas de bisturias

	unsteril non-sterile non-stérile no estériles	steril sterile stérile estériles
Fig. 10	37.1053-10	37.1063-10
Fig. 11	37.1053-11	37.1063-11
Fig. 12	37.1053-12	37.1063-12
Fig. 12d	37.1053-12D	37.1063-12D
Fig. 13	37.1053-13	37.1063-13
Fig. 15	37.1053-15	37.1063-15
Fig. 15c	37.1053-15C	37.1063-15C



Skalpellgriffe
Scalpel handles
Manches pour bistouris
Mangos de bisturias



37.1043 FIG. 3



37.1043-1



37.1033-1

37

37.1050

Klingenentferner
 Blade remover
 Enlève-lames
 Removedor de hojas



37

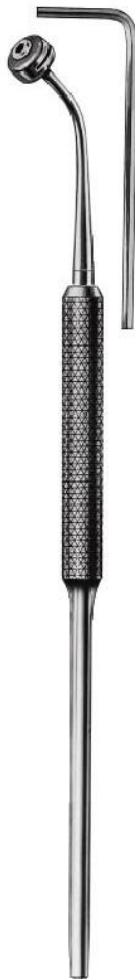

37.3405 BLAKE



37.1047 FIG. 7



- 37.1033-10** 1,0 mm
- 37.1033-15** 1,5 mm
- 37.1033-20** 2,0 mm
- 37.1033-25** 2,5 mm
- 37.1033-30** 3,0 mm

Parallelklingen-Skalpellgriff
 Parallel blade scalpel handle
 Lames parallèles-manches pour bistouris
 Hojas paralelas-mangos de bisturíes



- ▶ Extrem leichtes Schneiden
- ▶ Kein Abrutschen des Zahnfleisches
- ▶ Verringertes Trauma

- ▶ Extremely easy cutting
- ▶ No tissue slippage
- ▶ Reduced trauma

- ▶ Une coupe très facile
- ▶ Pas de glissement du tissu
- ▶ Réduction du traum

- ▶ Corta muy facil
- ▶ Tejido no se desliza
- ▶ Trauma reducido

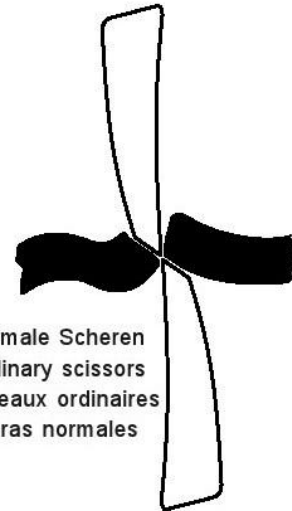

Normale Scheren
Ordinary scissors
Ciseaux ordinaires
Tijeras normales

37

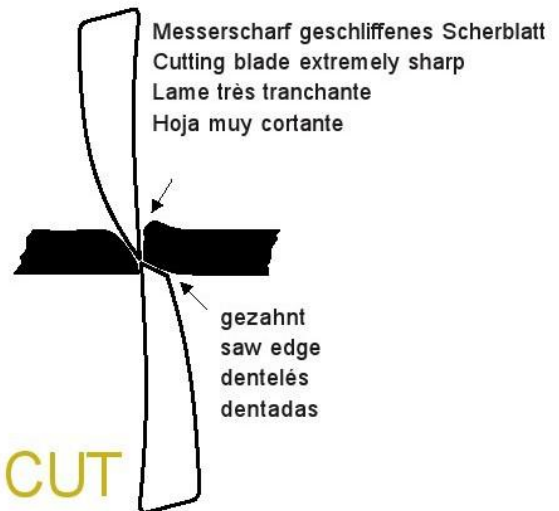

SUPER CUT



2/3
37.1110-400 SUPER CUT
11,5 cm



2/3
37.1111-400
11,5 cm



2/3
37.1143-400 KELLY
16 cm



2/3
37.1133-400 LA GRANGE
11,5 cm



2/3
37.1117-400 GOLDMANN-FOX
13 cm

37



37.1108

11,5 cm, schlank
11,5 cm, slim
11,5 cm, graciles
11,5 cm, delgadas

37.1109

11,5 cm, schlank
11,5 cm, slim
11,5 cm, graciles
11,5 cm, delgadas



37.1110 STANDARD
11,5 cm

37.1110-400 SUPER CUT

37.1180 TC GOLD
Hartmetalleinsätze
Tungsten carbide inserts
Mors en tungstène
Puntas de tungsteno



37.1111 STANDARD
11,5 cm

37.1111-400 SUPER CUT

37.1181 TC GOLD
Hartmetalleinsätze
Tungsten carbide inserts
Mors en tungstène
Puntas de tungsteno

37



37.1113
11,5 cm

37.1114
11,5 cm

37.1115
11,5 cm

37.1119 STEVENS
11,5 cm

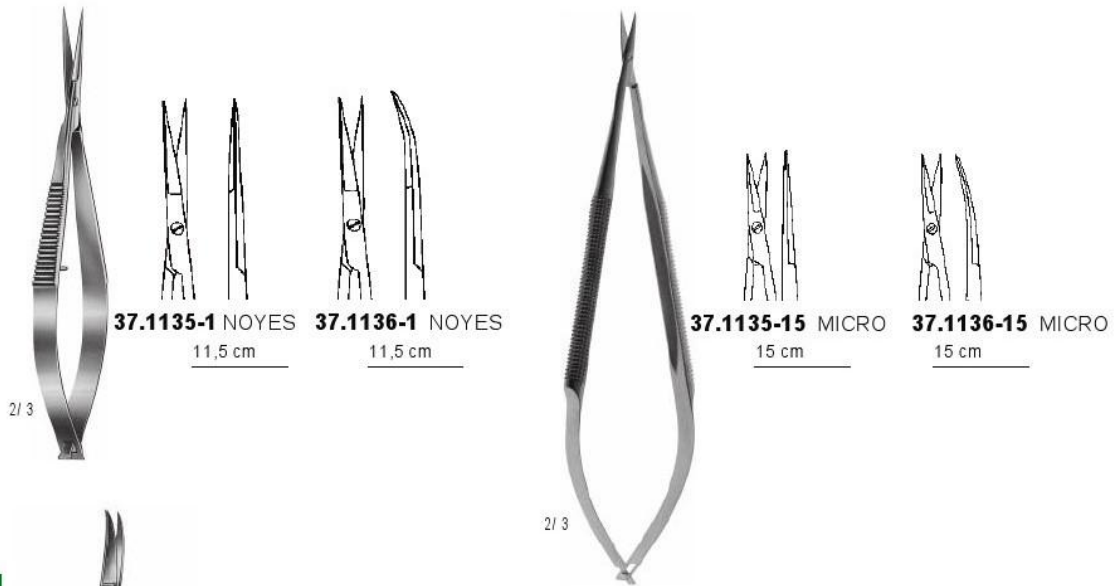

37



37.1133 LA GRANGE
 11,5 cm , gezahnt
 11,5 cm , saw edge
 11,5 cm , dentelés
 11,5 cm , dentadas

37.1133-400 SUPER CUT



37.1120
 12 cm

37.1121
 12 cm

37.1129 WAGNER
 12 cm , gezahnt
 12 cm , saw edge
 12 cm , dentelés
 12 cm , dentadas



2/3

37.1131 QUINBY

12,5 cm



2/3

37.1116 GOLDMANN-FOX

13 cm, gezahnt, gerade
13 cm, saw edge, straight
13 cm, dentelés, droits
13 cm, dentadas, recta



37



37.1117 GOLDMANN-FOX

13 cm, gezahnt, gebogen
13 cm, saw edge, curved
13 cm, dentelés, courbés
13 cm, dentadas, curvas



2/3

37.1117-400 SUPER CUT

37.1185 GOLDMANN-FOX TC GOLD

Hartmetalleinsätze
Tungsten carbide inserts
Mors en tungstène
Puntas de tungsteno



2/3

37.1117-1 GOLDMANN-FOX

13 cm, gezahnt, S-gebogen
13 cm, saw edge, S-curved
13 cm, dentelés, S-courbés
13 cm, dentadas, curvatura S

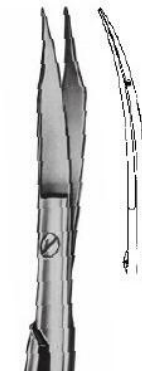

37



2/3

37.1124 JOSEPH
14 cm

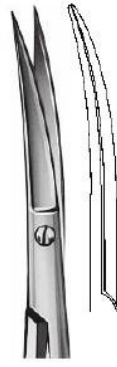

37.1125 JOSEPH
14 cm



2/3

37.1152 LOCKLIN
16 cm



2/3

37.1142 KELLY
16 cm

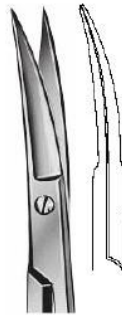

37.1143 KELLY
16 cm

37.1143-400 SUPER CUT



2/3

37.1147-1 DEAN
17,5 cm, gezahnt
17,5 cm, saw edge
17,5 cm, dentelés
17,5 cm, dentadas



Ligaturscheren
Ligature scissors
Ciseaux à ligatures
Tijeras para ligaduras



37.1168-11 SPENCER

11 cm



37.1168-200 SPENCER

11 cm



37.1168 SPENCER

9 cm



37.1169 LITTAUER

12,5 cm



37.1169-200 NORTHBENT

12,5 cm

37

37



37.1139-18 METZENBAUM
18 cm

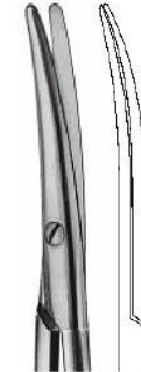

37.1139-14 METZENBAUM
14 cm

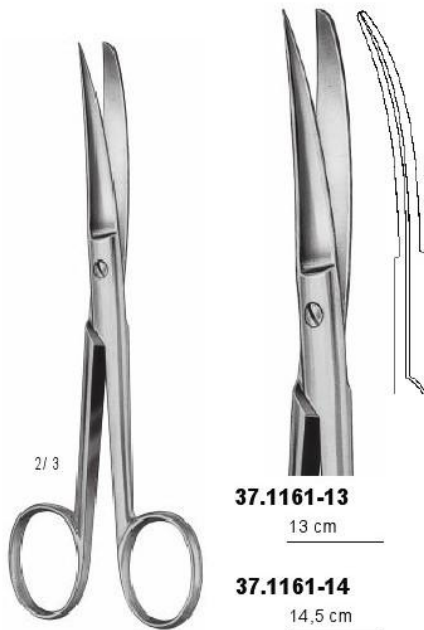

37.1161-13
13 cm

37.1161-14
14,5 cm



37.1162-13
13 cm

37.1162-14
14,5 cm

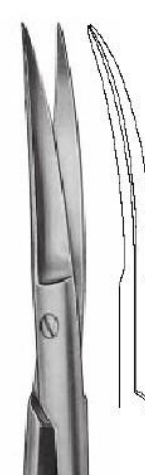

37.1163-13
13 cm

37.1163-14
14,5 cm



2/3



37.1207 ADSON

12 cm



37.1220-12 ADSON TC GOLD

12 cm, Hartmetalleinsätze

12 cm, tungsten carbide inserts

12 cm, mors en tungstène

12 cm, puntas de tungsteno



2/3



37.1207-115 MICRO-ADSON

15 cm, sehr fein

15 cm, very fine

15 cm, très fine

15 cm, muy finas

37



37.1197-13 SEMKEN

13 cm

37.1197-15 SEMKEN

15 cm



37.1201-13

13 cm

37.1201-14

14 cm



37.1205-13

13 cm

37.1205-14

14 cm

37.1205-162

16 cm, kreuzgeriefte Arbeitsenden

16 cm, cross-serrated tips

16 cm, pointes quadrillés

16 cm, puntas con forma de diamante



37

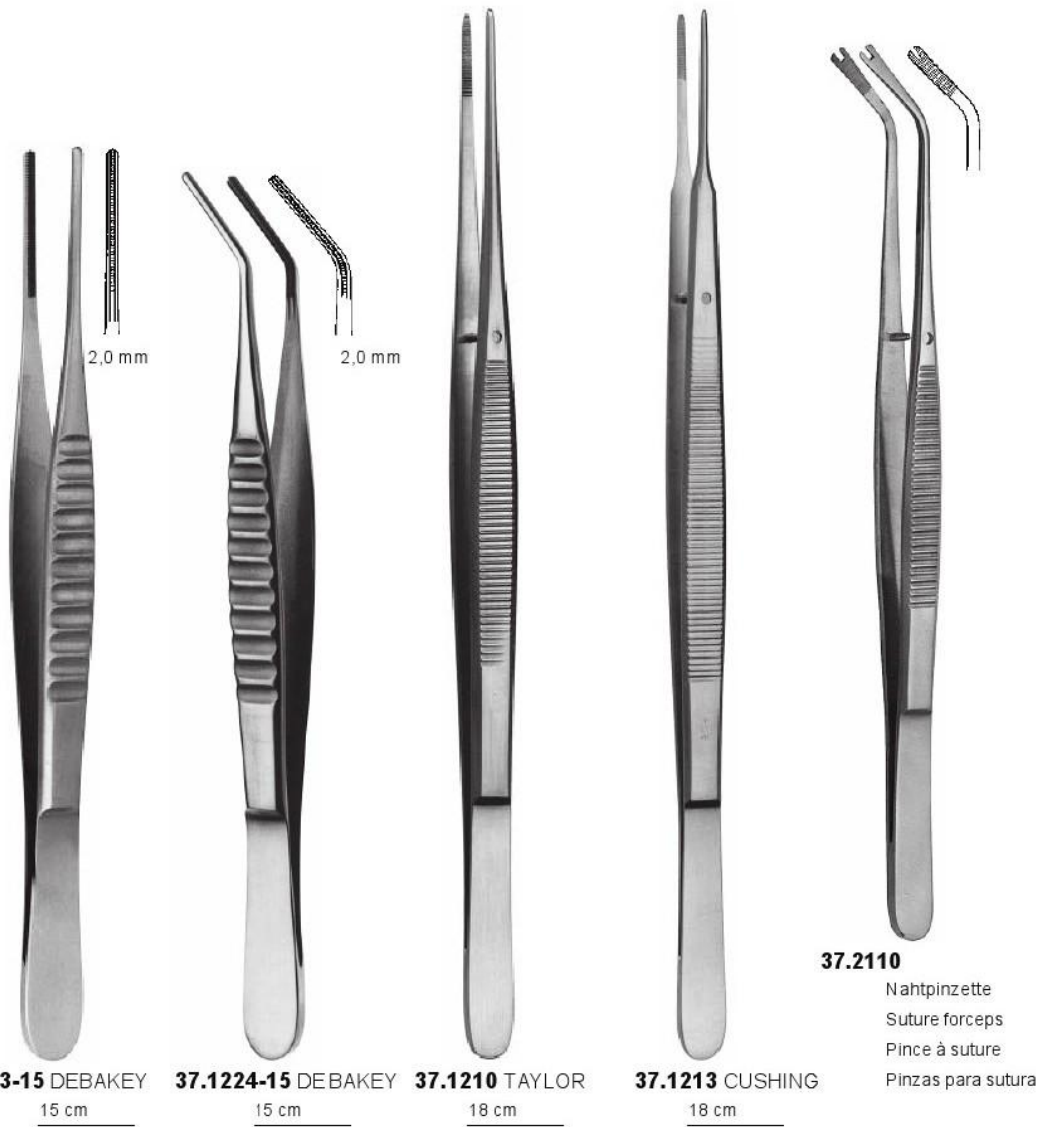

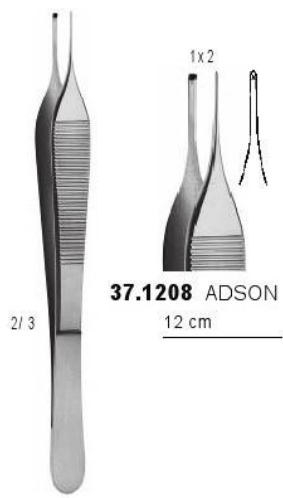

37.1208 ADSON
12 cm



37.1208-115 MICRO-ADSON
15 cm, sehr fein
15 cm, very fine
15 cm, très fine
15 cm, muy finas



37.1208-215 MICRO-ADSON
15 cm, sehr fein
15 cm, very fine
15 cm, très fine
15 cm, muy finas

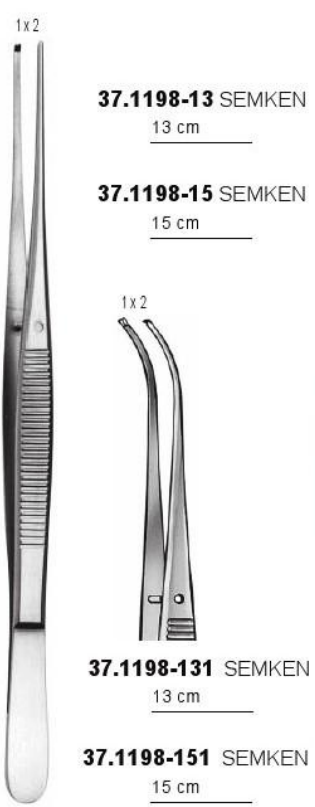

37.1198-13 SEMKEN
13 cm

37.1198-15 SEMKEN
15 cm

37.1198-131 SEMKEN
13 cm

37.1198-151 SEMKEN
15 cm



37.1202-13
13 cm

37.1202-14
14 cm



37.1206-13
13 cm

37.1206-14
14 cm



37.1218 GILLIES
16 cm

37

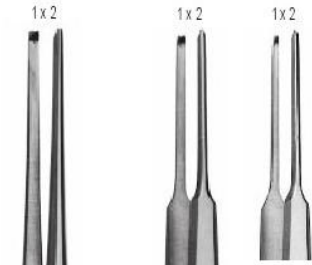

37.1214-1 MICRO CUSHING

18 cm, sehr fein
 18 cm, very fine
 18 cm, très fine
 18 cm, muy finas



37.1212 TAYLOR 18 cm **37.1214 CUSHIN** 18 cm

37.1222-1 FOX Gewebepinzette, 15,5 cm Gum seizing forceps, 15,5 cm Pince à gencive, 15,5 cm Pinzas para gingiva, 15,5 cm	37.1222 FOX mit Schloß with lock avec arrêt con cerradura	37.3426-1 CRANE-KAPLAN Taschenmarkierungspinzetten Pocket markers Pincas à marquer la poche Pinzas para marcar el sulco periodontal con cerradura, 20 cm	37.3426-2 mit Schloß, 20 cm with lock, 20 cm avec arrêt, 20 cm	37.1221-20 mit Schloß, 20 cm with lock, 20 cm avec arrêt, 20 cm
---	--	---	--	---

Arterienklemmen
 Haemostatic forceps
 Pinces hémostatiques
 Pinzas hemostáticas

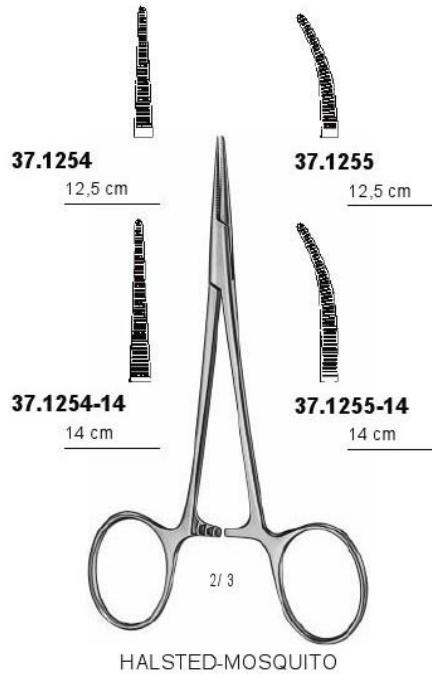

37





37.1284-9 BACKHAUS
 9 cm, Tuchklemme
 9 cm, towel clip
 9 cm, pince à champs
 9 cm, pinza de campo



37.1280 JONES
 8,5 cm, Tuchklemme
 8,5 cm, towel clip
 8,5 cm, pince à champs
 8,5 cm, pinza de campo

37.1284-11 BACKHAUS
 11 cm, Tuchklemme
 11 cm, towel clip
 11 cm, pince à champs
 11 cm, pinza de campo

37



37.1264 ALLIS
 15,5 cm, Zahnfleischfaßzange
 15,5 cm, gum seizing forceps
 15,5 cm, pince à gencive
 15,5 cm, pinze para filar la encía



37.1290-20 GROSS
 20 cm, Kornzange
 20 cm, dressing forceps
 20 cm, pince à pansement
 20 cm, pinza para curaciones



37.1291-20 GROSS
 20 cm, Kornzange
 20 cm, dressing forceps
 20 cm, pince à pansement
 20 cm, pinza para curaciones



37.1308-2

17 cm

37.1308-3

17 cm

UFFENORDE



37.1306-30

Fig. 000

37.1306-40

Fig. 0000

VOLKMANN

17 cm

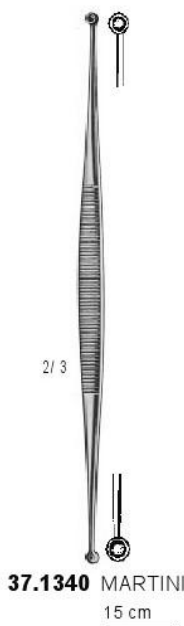

37.1340 MARTINI

15 cm



37.1342 WILLIGER

15 cm

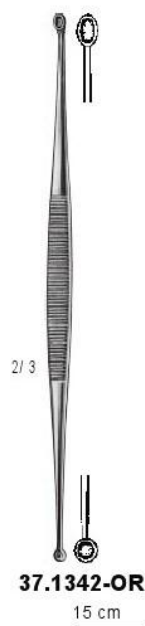

37.1342-OR

15 cm



37.1354

16 cm

37

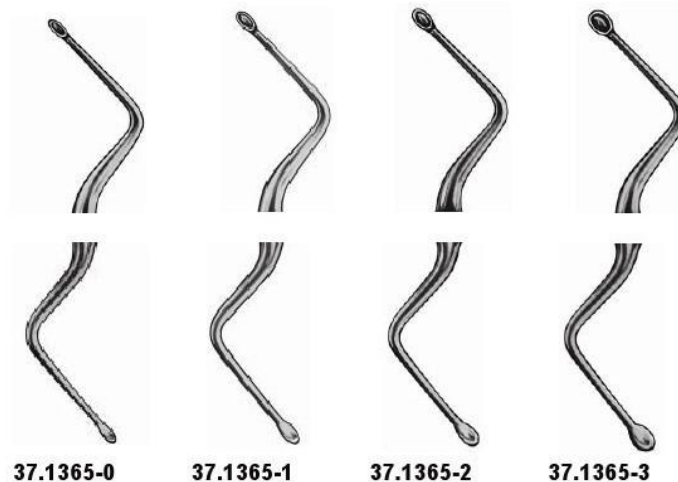
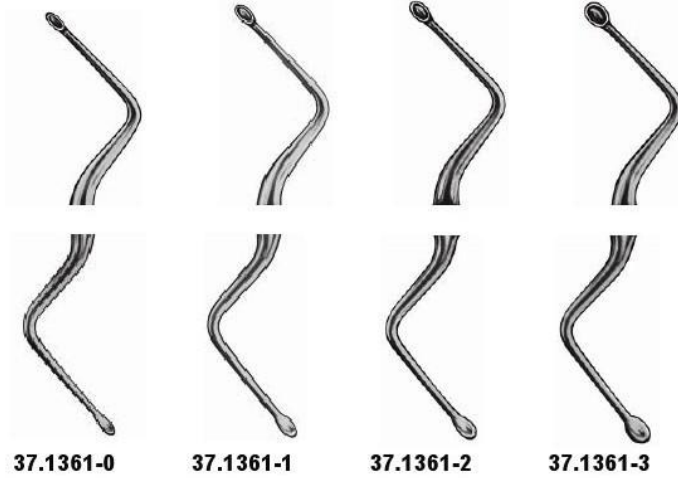
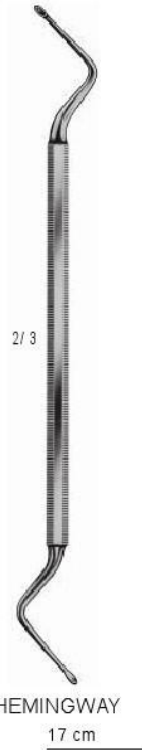

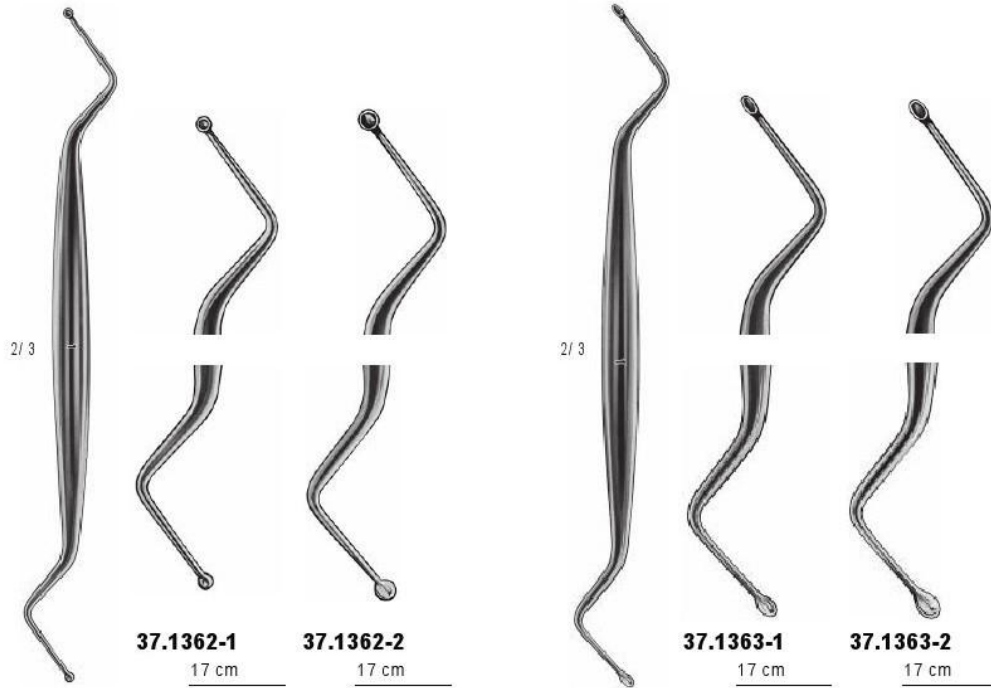

37

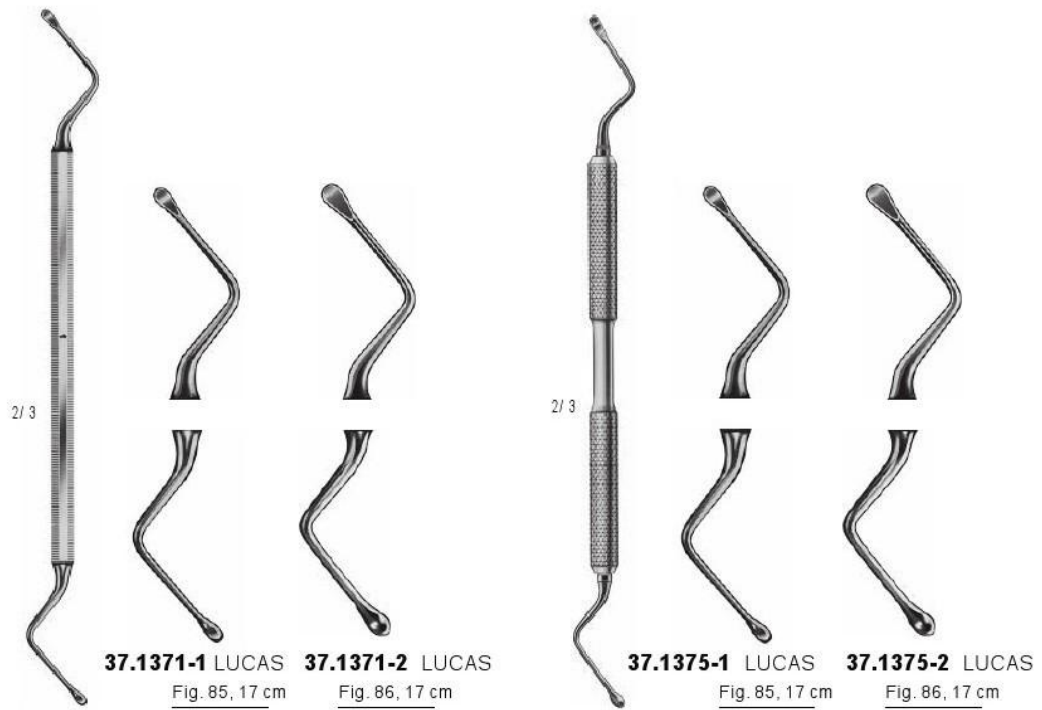

Raspatorien
 Raspatories
 Rugines-raspatoires
 Periostótomos

37

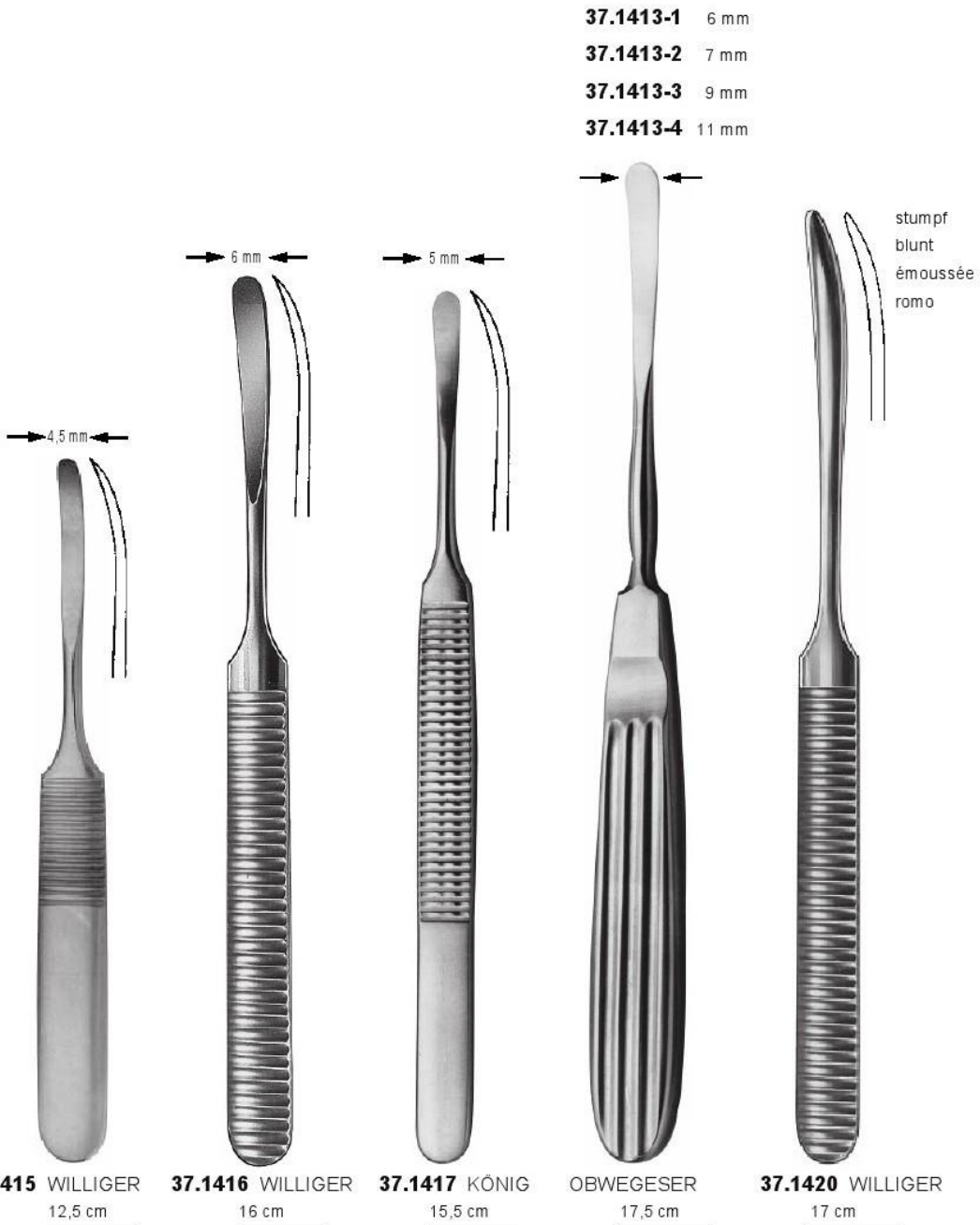

Raspatorien
 Raspatories
 Rugines-raspatoires
 Periostótomos

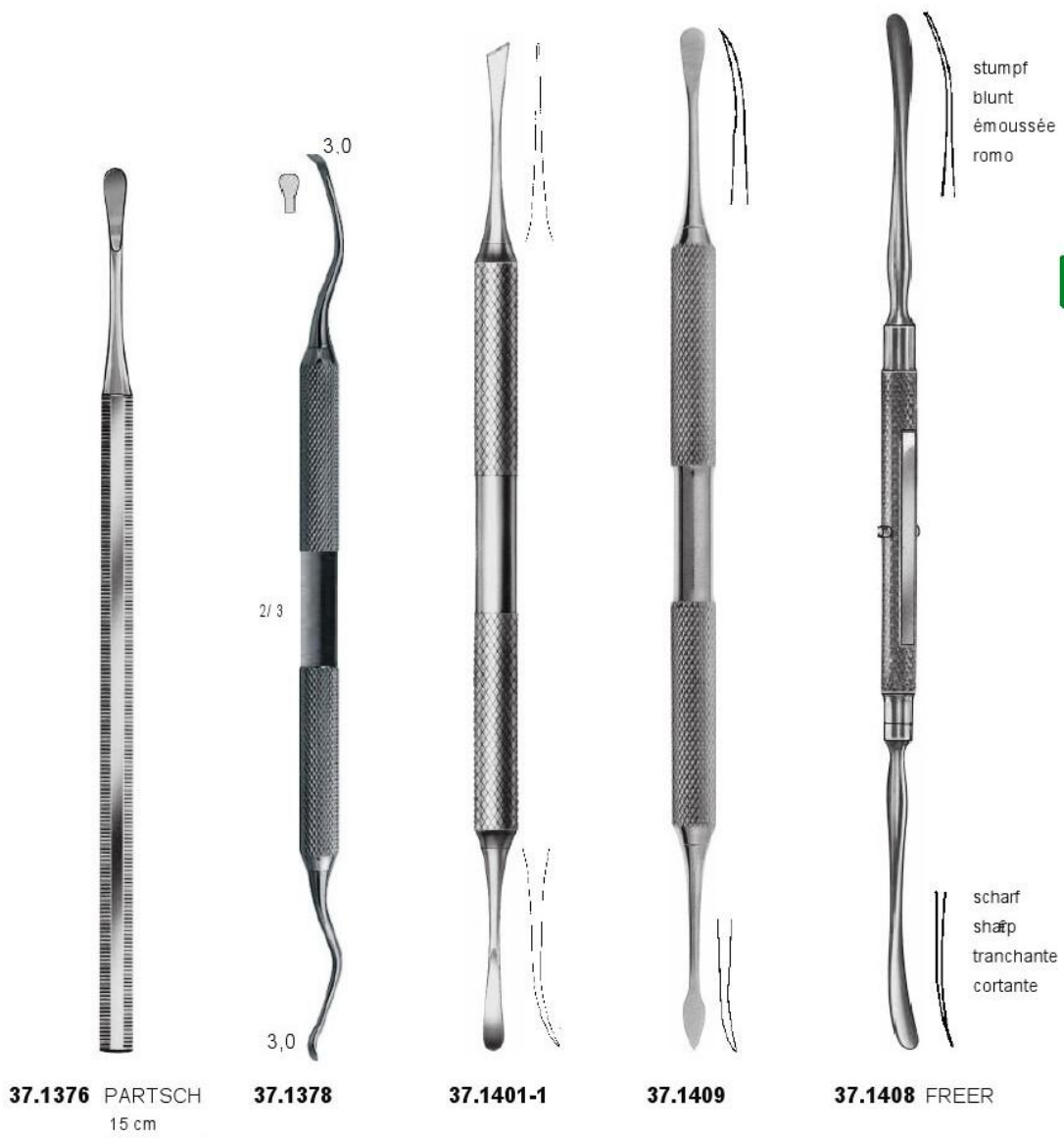

37

Raspatorien
Raspatories
Rugines-raspatoires
Periostótomos



Raspatorien
Raspatories
Rugines-raspatoires
Periostótomos



37

37.1405 PRICHARD

37.1401 WEST

37.1412-1 FREER
scharf
sharp
tranchante
cortante

37.1412-21 FREER
stumpf
blunt
émoussée
romo

37.1412-2 FREER
scharf
sharp
tranchante
cortante

37.1412-22 FREER
stumpf
blunt
émoussée
romo

Knochenfeilen	Chirurgische Küretten
Bone files	Surgical curettes
Râpes à os	Curettes à chirurgie
Limas de hueso	Curetas para cirugía

37



MILLER-COLBURN
 17 cm, Knochenfeilen
 17 cm, bone files
 17 cm, râpes à os
 17 cm, limas de hueso



37.3385-1 KRAMER **37.3385-2 KRAMER** **37.3385-3 KRAMER**

Meißel
Chisels
Burins
Cinceles



37.1650-2

37.1650-1 OCHSENBEIN
16 cm



37.1650-3 OCHSENBEIN
3



37.1650-4 OCHSENBEIN
4



37.1650-36 RHODES

37

Meißel
Chisels
Burins
Cinceles

37

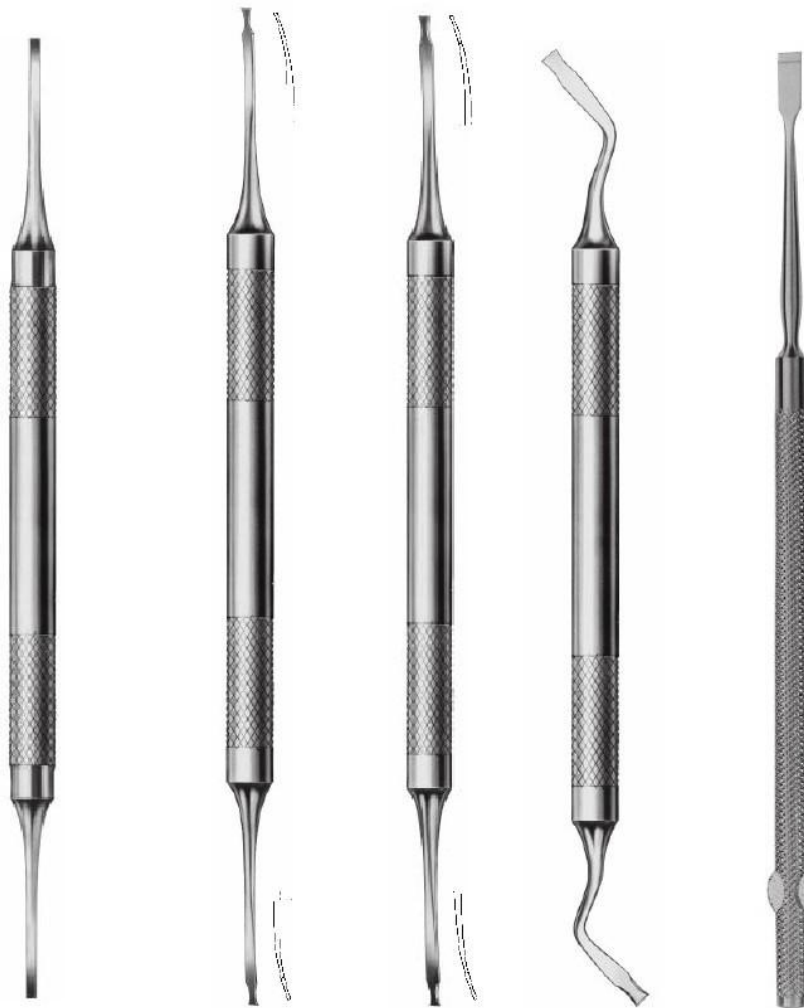

37.1650-12 KRAMER-NEVINS

37.1651-1 FEDI

37.1651-2 FEDI

37.1651-3 FEDI

37.1674-4 FREER

16 cm, 4 mm

Meißel
Chisels
Burins
Cinceles

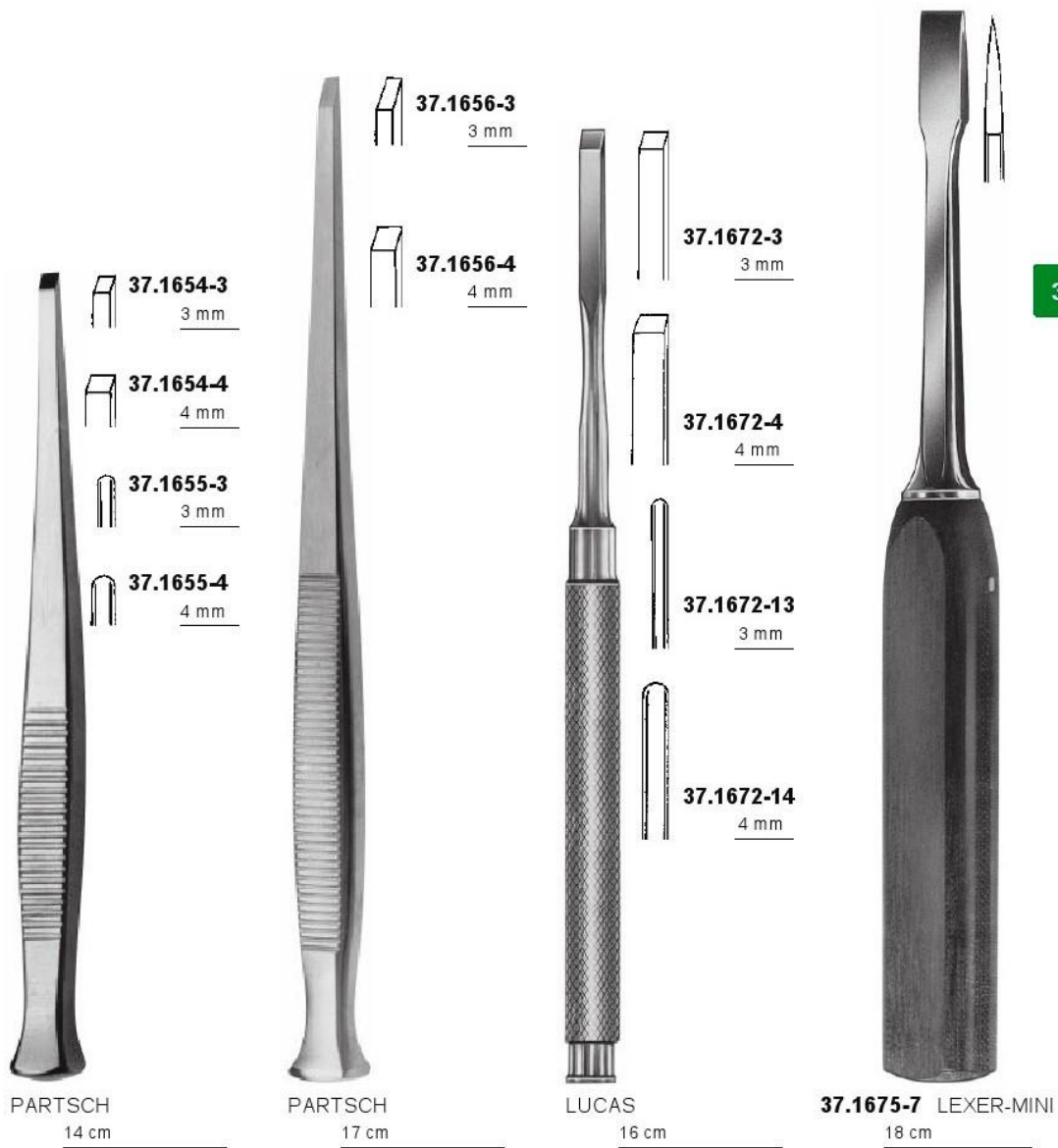

37

Meißel
Chisels
Burins
Cinceles

37



37.1682-4 EPKER 4 mm
37.1682-6 EPKER 6 mm
37.1682-8 EPKER 8 mm
 18 cm, gerade
 18 cm, straight
 18 cm, droit
 18 cm, recto



37.1682-16 EPKER 6 mm
37.1682-18 EPKER 8 mm
 18 cm, leicht gebogen
 18 cm, slightly curved
 18 cm, courbé légèrement
 18 cm, curvado levemente



37.1682-26 EPKER 6 mm
37.1682-28 EPKER 8 mm
 18 cm, stark gebogen
 18 cm, strong curved
 18 cm, courbé légèrement
 18 cm, curvo



1/2

37.1620 WILLIGER
 21 cm, 230 g, bleigefüllt
 21 cm, 230 g, lead filled
 21 cm, 230 g, garni de plomb
 21 cm, 230 g, relleno de plomo

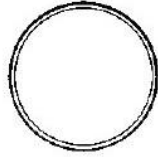

1/2

37.1621 WILLIGER
 21 cm, 200 g, rostfreier Stahl
 21 cm, 200 g, stainless steel
 21 cm, 200 g, acier inoxydable
 21 cm, 200 g, acero inoxidable

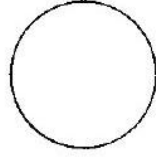

1/2

37.1626
 19 cm, 200 g, bleigefüllt
 19 cm, 200 g, lead filled
 19 cm, 200 g, garni de plomb
 19 cm, 200 g, relleno de plomo

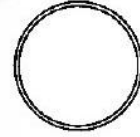

37

Bis 140°C sterilisierbar
 Sterilisation up to 140°C
 Stérilisables jusqu'à 140°C
 Esterilización hasta 140°C



1/2

auswechselbare Kunststoffeinsätze
 interchangeable plastic inserts
 interchangeables en matière plastique
 tapas de plástico intercambiables

37.1632 MEAD
 19 cm, 320 g
 19 cm, 320 g
 19 cm, 320 g
 19 cm, 320 g

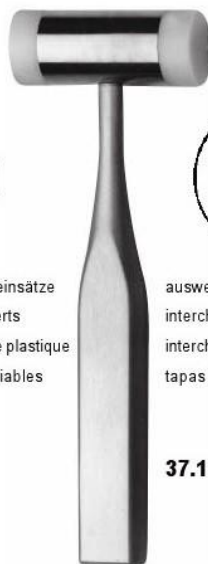
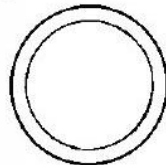

1/2

auswechselbare Kunststoffeinsätze
 interchangeable plastic inserts
 interchangeables en matière plastique
 tapas de plástico intercambiables

37.1637
 18,5 cm, 220 g
 18,5 cm, 220 g
 18,5 cm, 220 g
 18,5 cm, 220 g

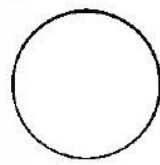

1/2

37.3740
 19 cm, 180 g, bleigefüllt
 19 cm, 180 g, lead filled
 19 cm, 180 g, rempli de plomb
 19 cm, 180 g, relleno de plomo

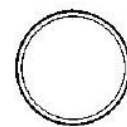

Periotome
Periotomes
Périotomes
Periótomos

Zur atraumatischen Trennung der Scharpey'schen Fasern im PA-Spalt zur schonenden Extraktion.

The specific instrument for atraumatic teeth extraction before implants are placed. No cortical bone damage with this instrument, it cuts the periodontal ligament carefully and easily.

37



37.1706-1



37.1706-2



Sinus Lift Küretten, stumpf
Sinus Lift Curette, blunt
Curette pour sinus lift, émoussée
Cureta para senos lift, romo

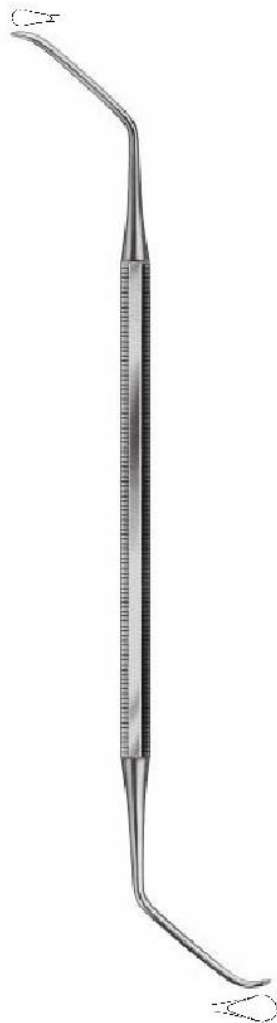

37.1430-1

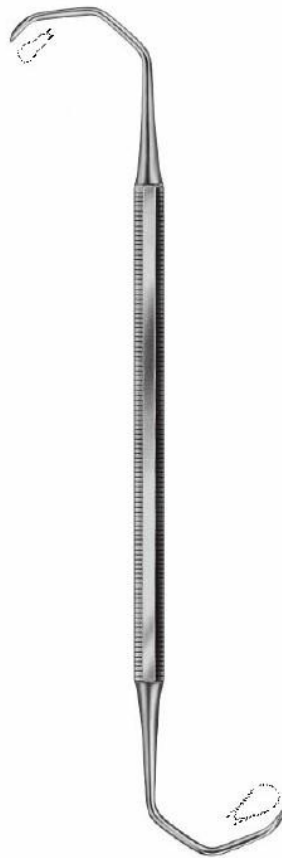

37.1430-2



37.1430-3

37

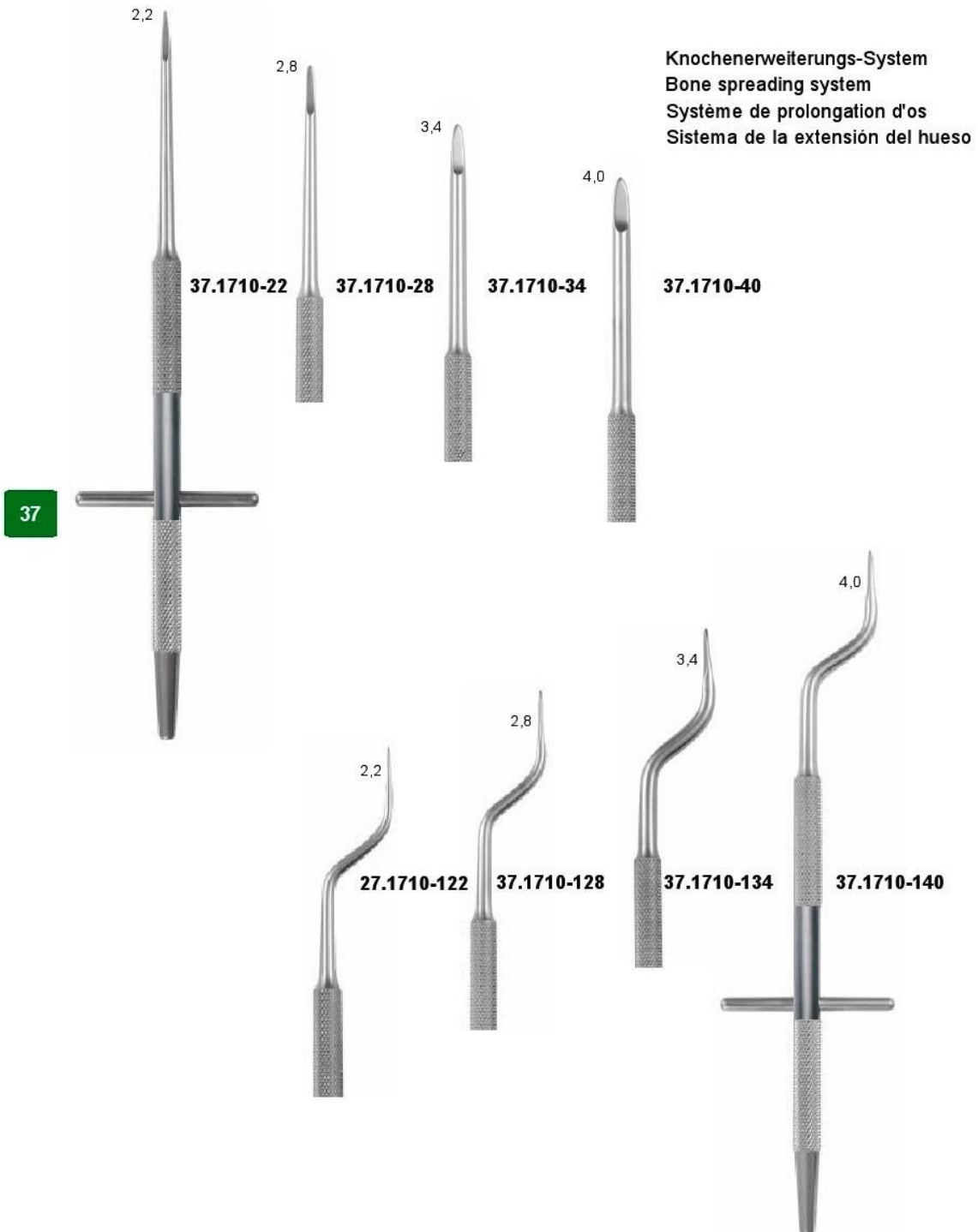

Sinusboden-Elevatoren
Sinus lift elevators
Sinus lift éleveurs
Senos lift elevadores

37.1700-500

Sieb mit 20 Instrumenten
 Tray with 20 instruments
 Plateaux avec 20 instruments
 Bandejas con 20 instrumentos

37.1700-510

Sieb, leer 275 x 175 x 25
 Tray, empty 275 x 175 x 25
 Plateau, vide 275 x 175 x 25
 Bandeja, vacío 275 x 175 x 25

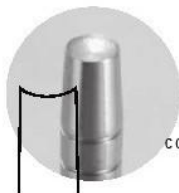

konkav, konisch, bajonett
 konkave, conical, bayonet

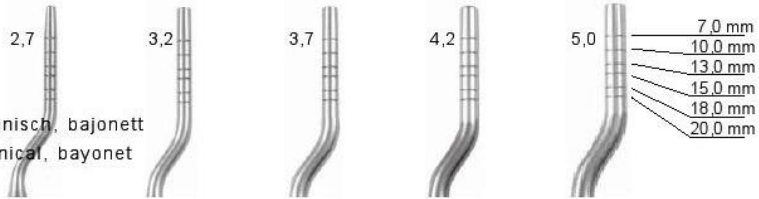

37.1701-127 37.1701-132 37.1701-137 37.1701-142 37.1701-150

Sinusboden-Elevatoren
Sinus lift elevators
Sinus lift elevateurs
Senos lift elevadores

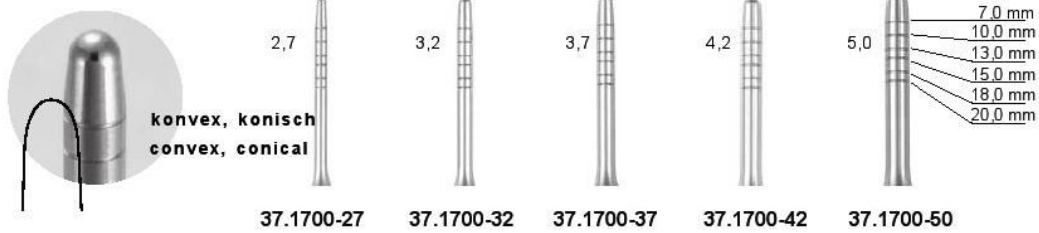

37

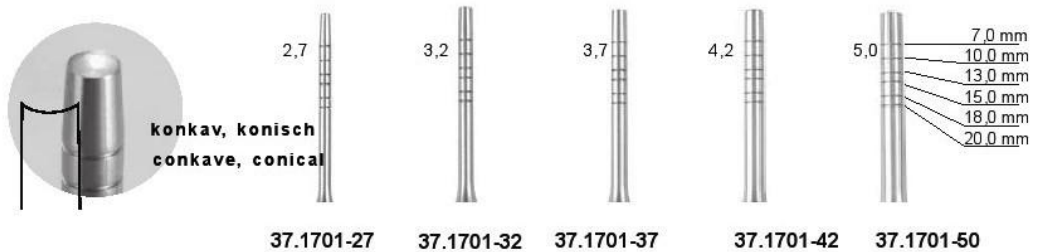
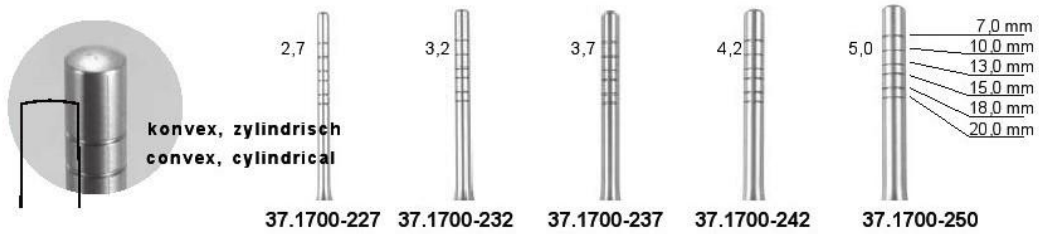
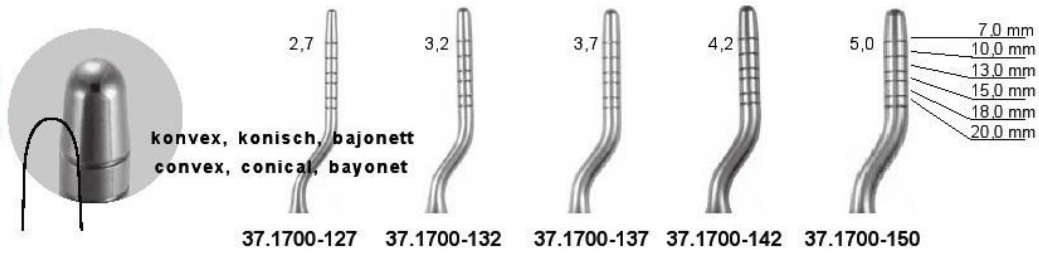

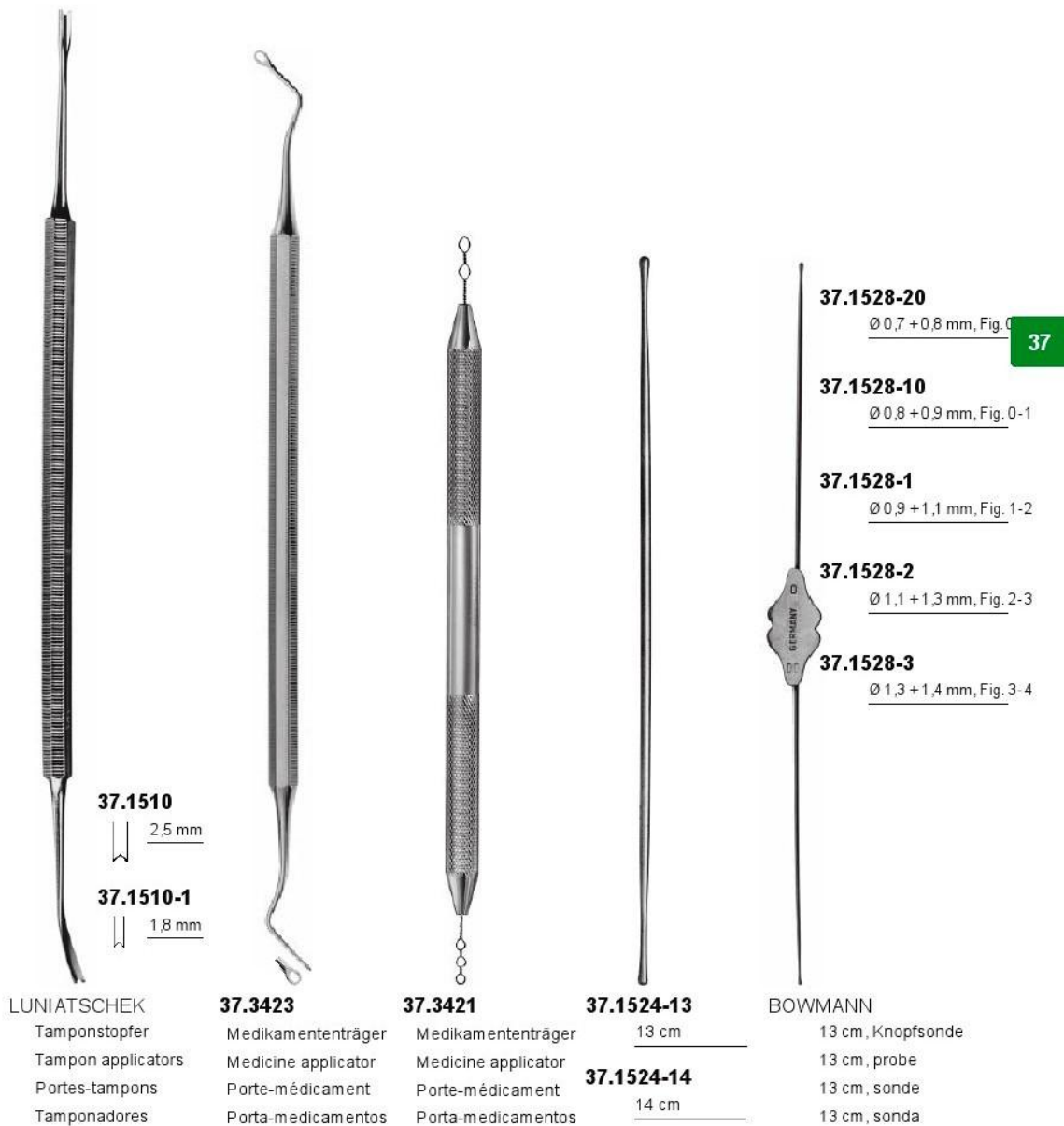

37



37.1863

16 cm, scharf
16 cm, sharp
16 cm, tranchant
16 cm, cortante



37.1868

16 cm, stumpf
16 cm, blunt
16 cm, mousse
16 cm, romo



37.1842 ROLLET

13 cm, scharf
13 cm, sharp
13 cm, tranchant
13 cm, cortante



37.1850 MÜLLER-SENN

16 cm, scharf
16 cm, sharp
16 cm, tranchant
16 cm, cortante



37.1838 KILNER

15 cm



37.1839-1

37.1839-2

GILLIES

18 cm



37.1836-1

10 x 6 mm

37.1836-2

20 x 6 mm

SENN-GREEN

16 cm

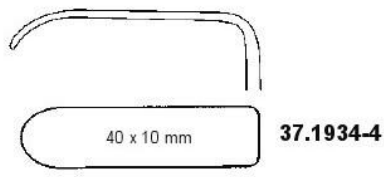
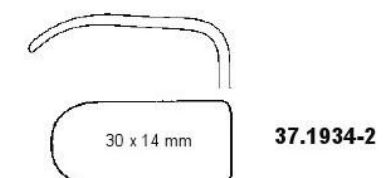
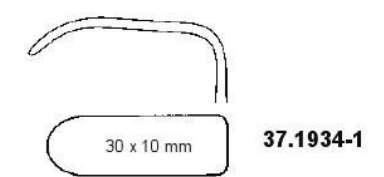
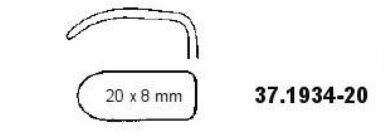

Kombinierter Wundhaken und Wangenhalter „Schäfer“

Doppelt funktionelles Instrument zum Abhalten des Lappens und der Wange bei chirurgischen Eingriffen wie Implantation und Wurzelspitzenresektion.

37

Combined wound and cheek retractor „Schäfer“

Dual-purpose instrument for the retraction of flaps and cheek during surgery such as implantation and apicetomy.



37



22 cm

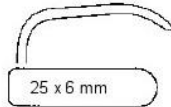

37.1940-50 KOCHER
25 x 6 mm



37.1940-1 KOCHER
40 x 10 mm

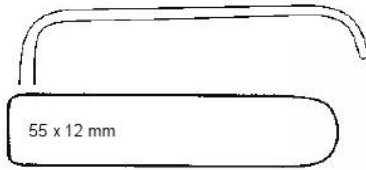

37.1940-2 KOCHER
55 x 12 mm



37.1944 RAMUS
72 x 11 mm



37.1946 SPINA NASALIS
40 x 10 mm



1/3

37.1947 BOWDLER-HENRY'S
16,5 cm



2/3

37.2559-1
18 cm, Ø 2 mm

37.2559-2
18 cm, Ø 3 mm

FRAZIER
Saugkanülen
Suction tubes
Canules pour aspiration
Canulas para aspiración



2/3

8,5 mm

37.2560 COGSWELL
Saugkanüle
Suction tube
Canule pour aspiration
Canula para aspiración

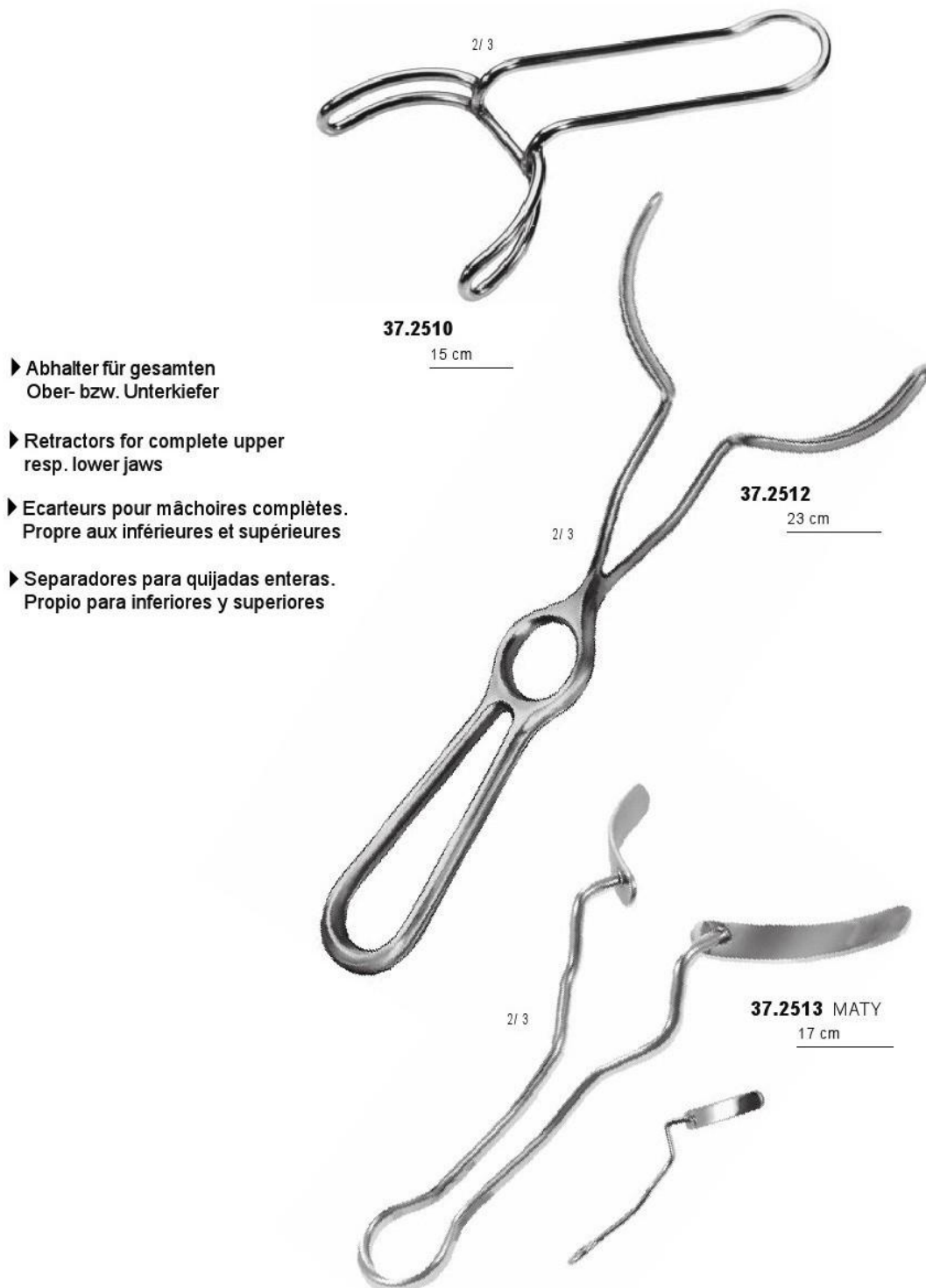

- ▶ Abhalter für gesamten Ober- bzw. Unterkiefer
- ▶ Retractors for complete upper resp. lower jaws
- ▶ Ecarteurs pour mâchoires complètes. Propre aux inférieures et supérieures
- ▶ Separadores para quijadas enteras. Propio para inferiores y superiores



37.2502-1 MIDDELDORPF
17 mm

2/3



37.2502-2 MIDDELDORPF
22 mm



37.2450 HILGER
Abhalter, passend auf Mundspiegelgriffe
Retractor, fits on mouth mirror handles
Ecarteur, compatible avec manches de miroirs à bouche
Separador, compatible con mangos para espejos intraorales



37.2332 LANGENBECK
Fingerschützer
Finger protector
Protège-doigts
Protector de dedos

2/3

37



37.2460 MINNESOTA
16 cm

2/3



37.2462 STERNBERG
16 cm

2/3



37.2470 ROUX
17 cm

2/3

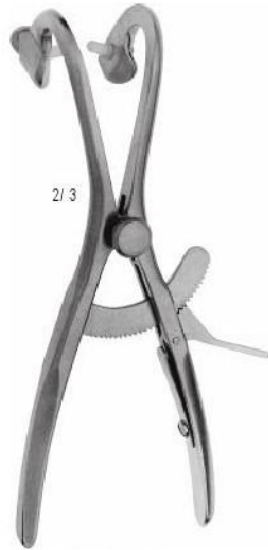

37.2205 DENHART
13 cm

37.2205-1

- 1 Paar Silikoneinlagen
- 1 pair of silicone inserts
- 1 paire de protecteurs silicones
- 1 pareja de silicón capas



37.2237 DOYEN-MOLT
10 cm - für Kinder, for children, pour enfants, para niños, per bambini

37.2238 DOYEN-MOLT

- 12 cm - für Erwachsene, for adults, pour adulte, per adulto, per adulto

Mundsperrer
Mouth gags
Ouvre-bouches
Abre-bocas

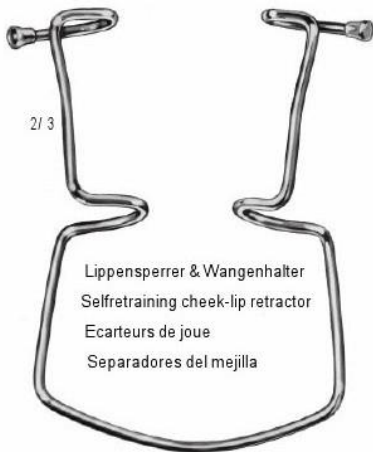

37.2465-1 ORINGER
klein, small, petit, pequeno

37.2465-2 ORINGER
mittel, medium, moyen, medio

37.2465-3 ORINGER
groß, large, grand, grande



Zungen-Drücker
Tongue depressor
Abaisse-langue
Depresor de lengua

37.2338-1 WIEDER
klein, small, petit, pequeno

37.2338-2 WIEDER
groß, large, grand, grande



37.2334 BUCHWALD
18 cm, Zungenspatel
18 cm, tongue depressor
18 cm, abaisse-langue
18 cm, abatelengua

37

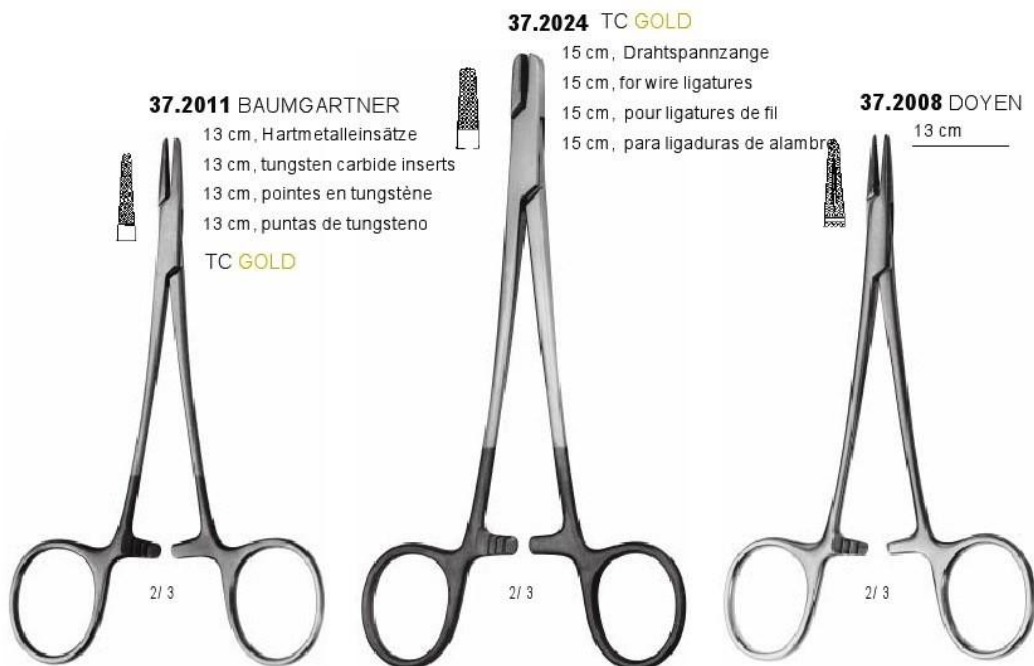
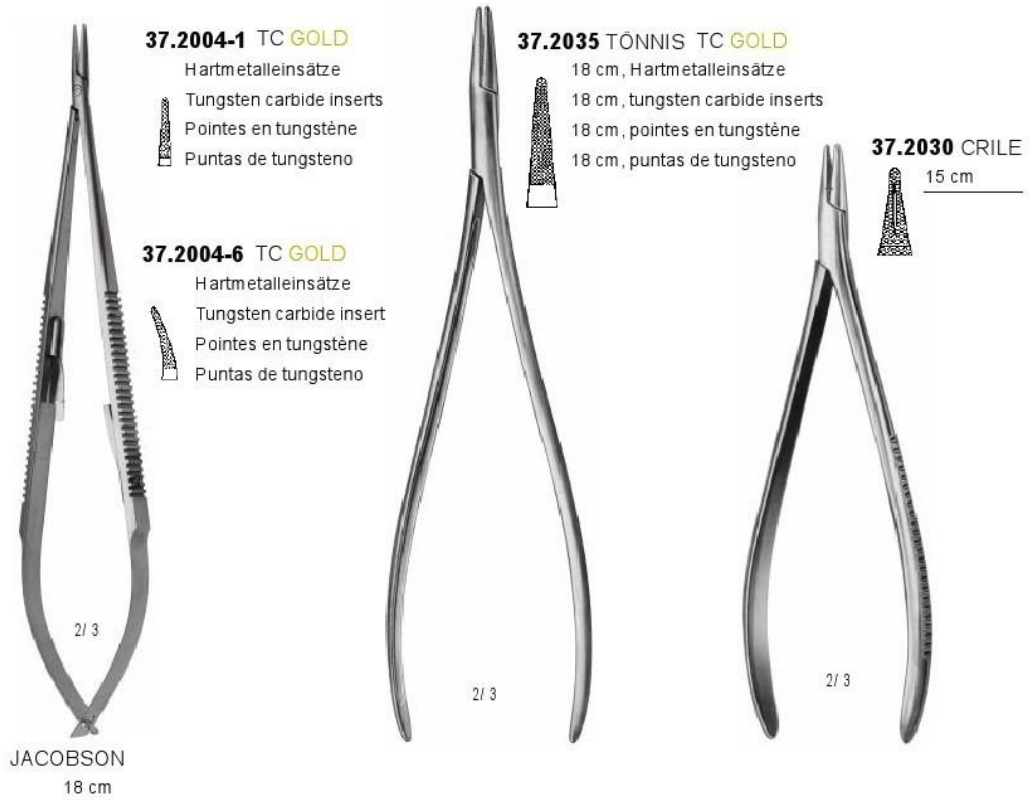

37

37.2012 CRILE-WOOD

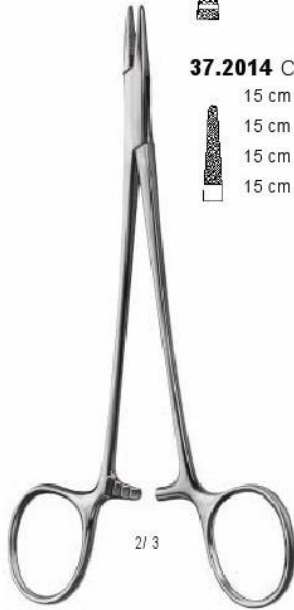

CRILE-WOOD

37.2014 CRILE-WOOD TC GOLD

- 15 cm, Hartmetalleinsätze
- 15 cm, tungsten carbide inserts
- 15 cm, pointes en tungstène
- 15 cm, puntas de tungsteno



MAYO-HEGAR

37.2016-16

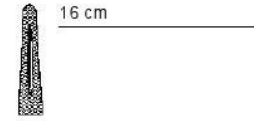

37.2018-16 TC GOLD

- 16 cm, Hartmetalleinsätze
- 16 cm, tungsten carbide inserts
- 16 cm, pointes en tungstène
- 16 cm, puntas de tungsteno



37.2016-18

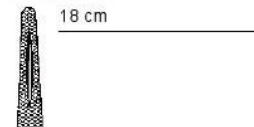

37.2018-18 TC GOLD

- 18 cm, Hartmetalleinsätze
- 18 cm, tungsten carbide inserts
- 18 cm, pointes en tungstène
- 18 cm, puntas de tungsteno



37.2020-16 TC GOLD

- 16 cm, Hartmetalleinsätze
- 16 cm, tungsten carbide inserts
- 16 cm, pointes en tungstène
- 16 cm, puntas de tungsteno

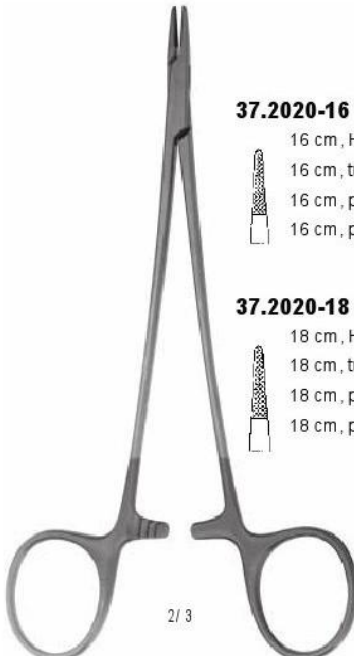

DE BAKEY

37.2020-18 TC GOLD

- 18 cm, Hartmetalleinsätze
- 18 cm, tungsten carbide inserts
- 18 cm, pointes en tungstène
- 18 cm, puntas de tungsteno



CRILE-RYDER

37.2022-13 TC GOLD

- 13 cm, Hartmetalleinsätze
- 13 cm, tungsten carbide inserts
- 13 cm, pointes en tungstène
- 13 cm, puntas de tungsteno

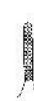

37.2022-15 TC GOLD

- 15 cm, Hartmetalleinsätze
- 15 cm, tungsten carbide inserts
- 15 cm, pointes en tungstène
- 15 cm, puntas de tungsteno



37.2022-18 TC GOLD

- 18 cm, Hartmetalleinsätze
- 18 cm, tungsten carbide inserts
- 18 cm, pointes en tungstène
- 18 cm, puntas de tungsteno



37

37.2012 CRILE-WOOD



CRILE-WOOD

37.2014 CRILE-WOOD TC GOLD

- 15 cm, Hartmetalleinsätze
- 15 cm, tungsten carbide inserts
- 15 cm, pointes en tungstène
- 15 cm, puntas de tungsteno



MAYO-HEGAR

37.2016-16

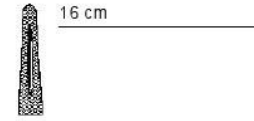

37.2018-16 TC GOLD

- 16 cm, Hartmetalleinsätze
- 16 cm, tungsten carbide inserts
- 16 cm, pointes en tungstène
- 16 cm, puntas de tungsteno



37.2016-18

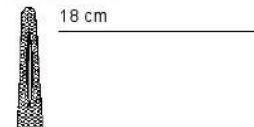

37.2018-18 TC GOLD

- 18 cm, Hartmetalleinsätze
- 18 cm, tungsten carbide inserts
- 18 cm, pointes en tungstène
- 18 cm, puntas de tungsteno



37.2020-16 TC GOLD

- 16 cm, Hartmetalleinsätze
- 16 cm, tungsten carbide inserts
- 16 cm, pointes en tungstène
- 16 cm, puntas de tungsteno



DE BAKEY

37.2020-18 TC GOLD

- 18 cm, Hartmetalleinsätze
- 18 cm, tungsten carbide inserts
- 18 cm, pointes en tungstène
- 18 cm, puntas de tungsteno



CRILE-RYDER

37.2022-13 TC GOLD

- 13 cm, Hartmetalleinsätze
- 13 cm, tungsten carbide inserts
- 13 cm, pointes en tungstène
- 13 cm, puntas de tungsteno

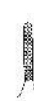

37.2022-15 TC GOLD

- 15 cm, Hartmetalleinsätze
- 15 cm, tungsten carbide inserts
- 15 cm, pointes en tungstène
- 15 cm, puntas de tungsteno



37.2022-18 TC GOLD

- 18 cm, Hartmetalleinsätze
- 18 cm, tungsten carbide inserts
- 18 cm, pointes en tungstène
- 18 cm, puntas de tungsteno





37.2050-12 BOYNTON
 12 cm, Hartmetalleinsätze
 12 cm, tungsten carbide inserts
 12 cm, mors en tungstène
 12 cm, puntas de tungsteno



37.2059 LICHTENBERG-RYDER
 14 cm, Hartmetalleinsätze
 14 cm, tungsten carbide inserts
 14 cm, pointes en tungstène
 14 cm, puntas de tungsteno

37.2062 MATHIEU-EISELSBERG
 19 cm



37



MATHIEU
 14 cm



37.2052



37.2053

37.2057-1 TC GOLD
 Hartmetalleinsätze
 Tungsten carbide inserts
 Pointes en tungstène
 Puntas de tungsteno



37.2057 TC GOLD
 Hartmetalleinsätze
 Tungsten carbide inserts
 Pointes en tungstène
 Puntas de tungsteno



MATHIEU
 17 cm



37.2054



37.2056

37.2058 TC GOLD
 Hartmetalleinsätze
 Tungsten carbide inserts
 Pointes en tungstène
 Puntas de tungsteno



2/3



37.2135-OG 2-5 ▼



37.2127-G 13-16 ▼

Nähnadeln mit Federöhr
 Suture needles with spring eye
 Aiguilles à suture avec chas à ressort
 Aguja para sutura con ojo de resorte



37

2/3



37.2150

Nadeldose, Ø 65 mm
 Needle case, Ø 65 mm
 Boîte à aiguilles, Ø 65 mm
 Cajita para agujas, Ø 65 mm

37.2150-1

Innendose gelocht
 Interior box punched
 Boîte à l'intérieur perforé
 Caja interior perforado



37.2110

Nahtpinzette
 Suture forceps
 Pince à suture
 Pinzas para sutura



2/3

Instrumentenbehälter
Instrument trays
Boîtes pour instruments
Recipientes para instrumentos

37.2617-1

200 x 100 x 35 mm

37.2617-2

260 x 150 x 50 mm

37.2617-3

300 x 200 x 50 mm



2/3

Nierenschalen
Kidney bowls
Bassins réniformes
Riñoneras

37.2619-1

170 x 100 x 35 mm

37.2619-2

250 x 140 x 40 mm

37.2619-3

275 x 150 x 45 mm

37



2/3

37.2610 METHOT

Wattebehälter
Cotton holder
Réceptient pour coton
Algodonera



2/3

37.2613 METHOT

für Watteabfälle
waste receiver
pour déchets de coton
para desechos de algodón

Zylinder-Ampullen-Spritzen
Cartridge syringes
Seringues d'ampoules
Jeringas de ampollas



37.2666-18

1,8 cc

37.2666-22

2,2 cc

Metrisches Gewinde

Metric thread

Vis métrique

Rosca métrica

37.2666-18 US

1,8 cc

37.2666-22 US

2,2 cc

US-Gewinde

US-thread

Vis amérique

Rosca americana

Ohne Aspiration
Without aspiration device
Sans aspiration
Sin aspiración

37



37.2668-18

1,8 cc

37.2668-22

2,2 cc

Metrisches Gewinde

Metric thread

Vis métrique

Rosca métrica

37.2668-18 US

1,8 cc

37.2668-22 US

2,2 cc

US-Gewinde

US-thread

Vis amérique

Rosca americana

Mit Aspiration
With aspiration device
Avec aspiration
Con aspiración



2/3

37.2716

10 cc

Wasserspritze selbstfüllend

Water syringe aspirating

Seringue à eau auto-aspirante

Jeringa de agua autoaspirante

Castroviejo Zirkel
Castroviejo calipers
Castroviejo étriers
Castroviejo calibreadores



37.1730-1, 9 cm
40 mm, gerade
40 mm, straight
40 mm, droit
40 mm, recto



37.1730-6, 9 cm
40 mm, 45° gewinkelt
40 mm, 45° angled
40 mm, 45°
40 mm, 45°

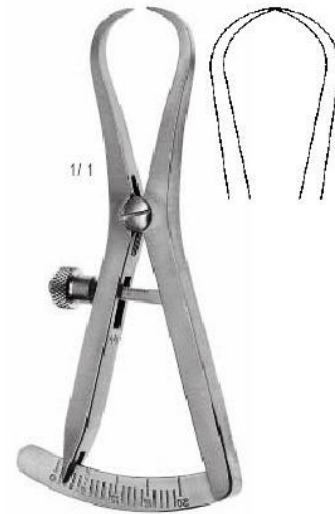

37.1730-4, 9 cm
20 mm, für Implantat
20 mm, for implants
20 mm,
20 mm,

37



37.1731-1, 18 cm
40 mm, gerade
40 mm, straight
40 mm, droit
40 mm, recto

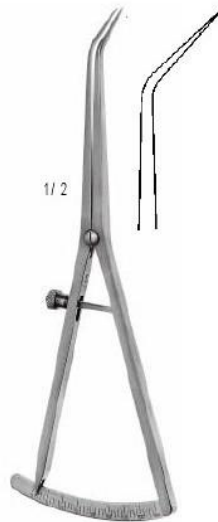

37.1731-6, 18 cm
40 mm, gewinkelt
40 mm, angled
40 mm,
40 mm,

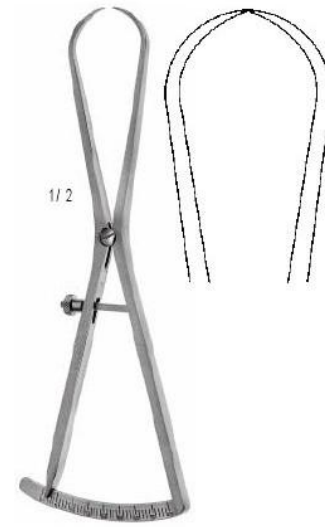

37.1731-4, 18 cm
40 mm, für Implantat
40 mm, for implants
40 mm,
40 mm,



38

DIAGNOSIS
DIAGNOSTIK
DIAGNOSTIC
DIAGNÓSTICO

Mundspiegelgriffe
 Mouth mirror handles
 Manches à miroirs
 Mangos a espejos



38.2770

Serviettenhalter, Länge verstellbar
 Napkin holder, length variable
 Porte-serviette, longueur changeable
 Porta-servilleta, tamaño variable



38.2780



38.2782



38.2783



38.2784

hohl
 hollow
 creux
 hueco



38.2786-1 ECONOMY

hohl
 hollow
 creux
 hueco



38.2787

hohl
 hollow
 creux
 hueco

38

38

- ▶ Scharfes + verzerrungsfreies Spiegelbild durch reflektierende Metallschicht direkt auf der Glasoberfläche
- ▶ Sharp + distortion free mirror image through reflective metal layer directly on glass surface

38.2806-4 RHODIUM
 Mega-Spiegel - plan, Fig. 4
 Mega mirror - plane, Fig. 4
 Mega miroir - plan, Fig. 4
 Mega espejo - plano, Fig. 4



38.2804-4 RHODIUM

plan
 plane
 plan
 plano

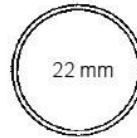

38.2805-4 RHODIUM

vergrößernd
 magnifying
 agrandissant
 de aumento

38.2804-5 RHODIUM

plan
 plane
 plan
 plano

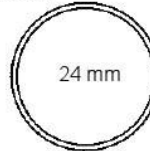

38.2805-5 RHODIUM

vergrößernd
 magnifying
 agrandissant
 de aumento

38.2808-3 RHODIUM MICRO

3 mm



38.2808-5 RHODIUM MICRO

5 mm



38.2808-36 RHODIUM MICRO

3 x 6 mm



38.2800-3

plan
 plane
 plan
 plano

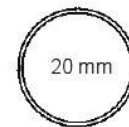

38.2800-4

plan
 plane
 plan
 plano

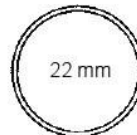

38.2801-4

vergrößernd
 magnifying
 agrandissant
 de aumento

38.2800-5

plan
 plane
 plan
 plano

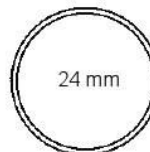

38.2801-5

vergrößernd
 magnifying
 agrandissant
 de aumento

Diamantierte Spitzen zum Entfernen von Fremdkörpern
Diamonded tips for removing foreign bodies
Pointes diamantées pour écarter corps étrangers
Puntas diamantadas para sacar cuerpos extraños

- ▶ **Überlegene Rostsicherheit** durch extra polierte Schweißnaht
- ▶ **Sicherer Schluß auch unter Druck** durch besonderen Stopstift

- ▶ **Superior corrosion resistance** through specially polished weld
- ▶ **Secure closing even under pressure** through special stopping pin

- ▶ **Meilleur résistance à la rouille** par une soudure fourbie spécialement
- ▶ **Fermeture assurée même sous compression** par un arrêt spécial

- ▶ **Mejor protección contra el moho** por una soldadura pulida
- ▶ **Cierra seguramente aun con compresión** por una espiga particular

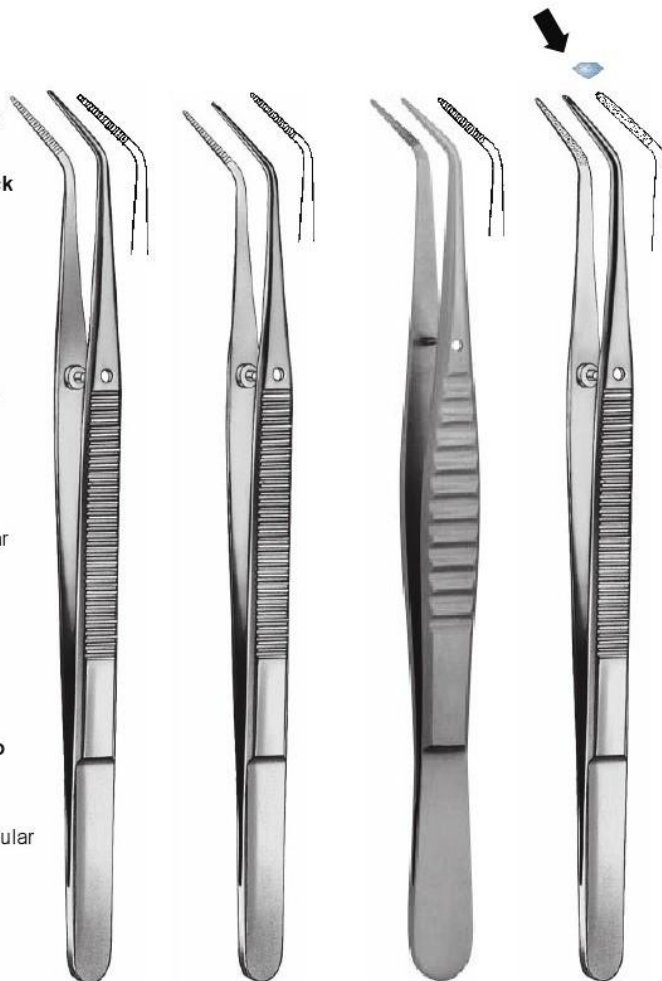

38

38.2885 COLLEGE	38.2886 COLLEGE	38.2887 COLLEGE	38.2888 COLLEGE
gerieft	feine Spitzen	kräftige Spitzen	diamantierte Spitzen
serrated	fine tips	strong tips	diamonded tips
striée	pointes fines	pointes robustes	pointes diamantées
estriada	puntas finas	puntas fuertes	puntas diamantadas



verhindert das Übereinandergleiten der Spitzen
 prevents side-slipping of tips
 évite le glissement latéral des pointes
 evita que las puntas se desvien al lado

38



- | | | | | | |
|------------------------|------------------------|------------------------|------------------------|------------------------|----------------------|
| 38.2884 COLLEGE | 38.2889 COLLEGE | 38.2880 COLLEGE | 38.2881 COLLEGE | 38.2883 COLLEGE | 38.2988 |
| glatt | gerieft mit Schloß | glatt | gerieft | gerieft | für Silberspitzen |
| smooth | serrated with ratchet | smooth | serrated | serrated | for silver points |
| lisse | striée avec arrêt | lisse | striée | striée | pour cônes d'argent |
| lisa | estriada con cierre | lisa | estriada | estriada | para puntas de plata |



verhindert das Übereinandergleiten der Spitzen
 prevents side-slipping of tips
 évite le glissement latéral des pointes
 evita que las puntas se desvien al lado

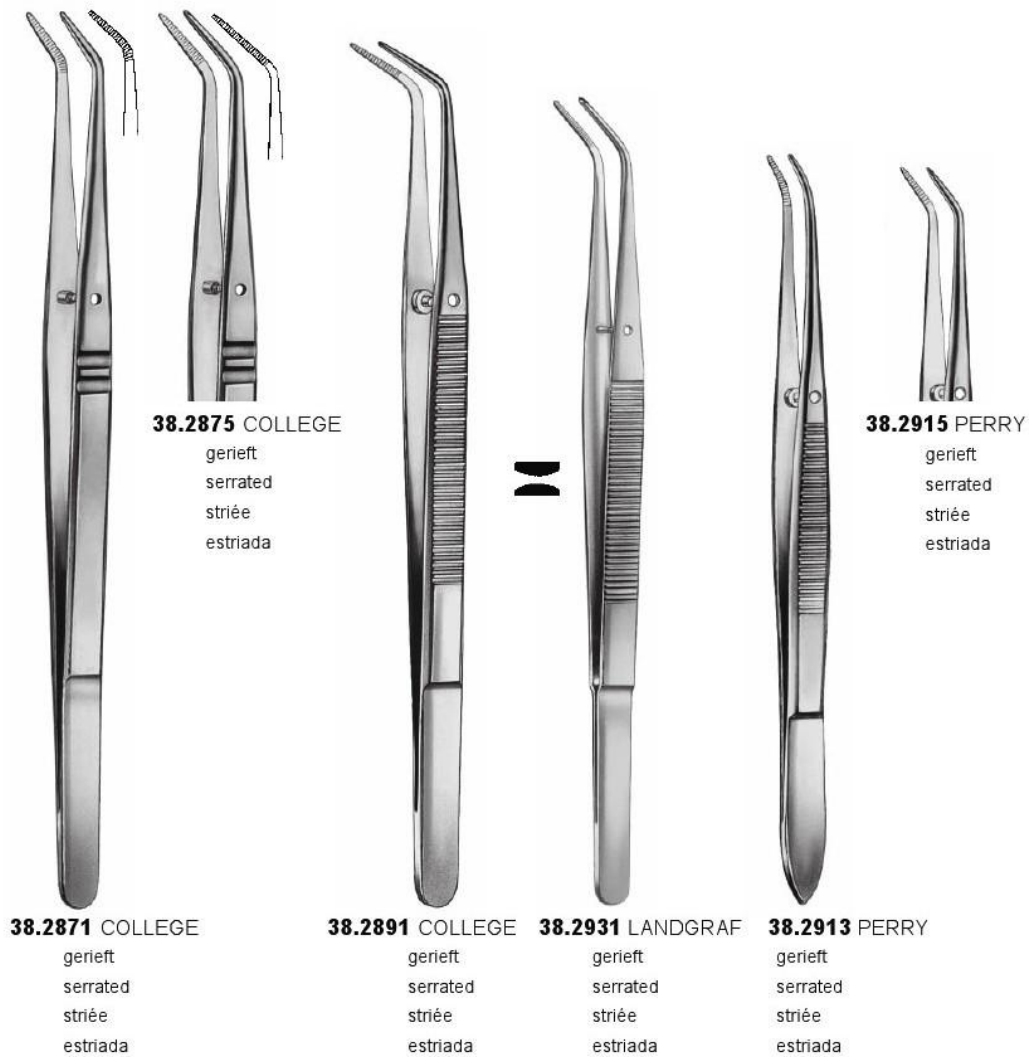

Diamantierte Spitzen zum Entfernen von Fremdkörpern
Diamonded tips for removing foreign bodies
Pointes diamantées pour écarter corps étrangers
Puntas diamantadas para sacar cuerpos extraños

38



38.2921 FLAGG
gerieft
serrated
striée
estriada

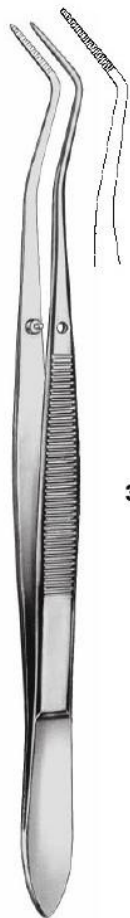

38.2943 MERIAM
gerieft
serrated
striée
estriada

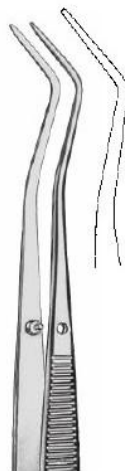

38.2942 MERIAM
glatt
smooth
lisse
lisa



38.2948 MERIAM
diamantierte Spitzen
diamonded tips
pointes diamantées
puntas diamantadas



38.2959 MERIAM
gerieft
serrated
striée
estriada

Zahnsonden
Explorers
Sondes
Sondas

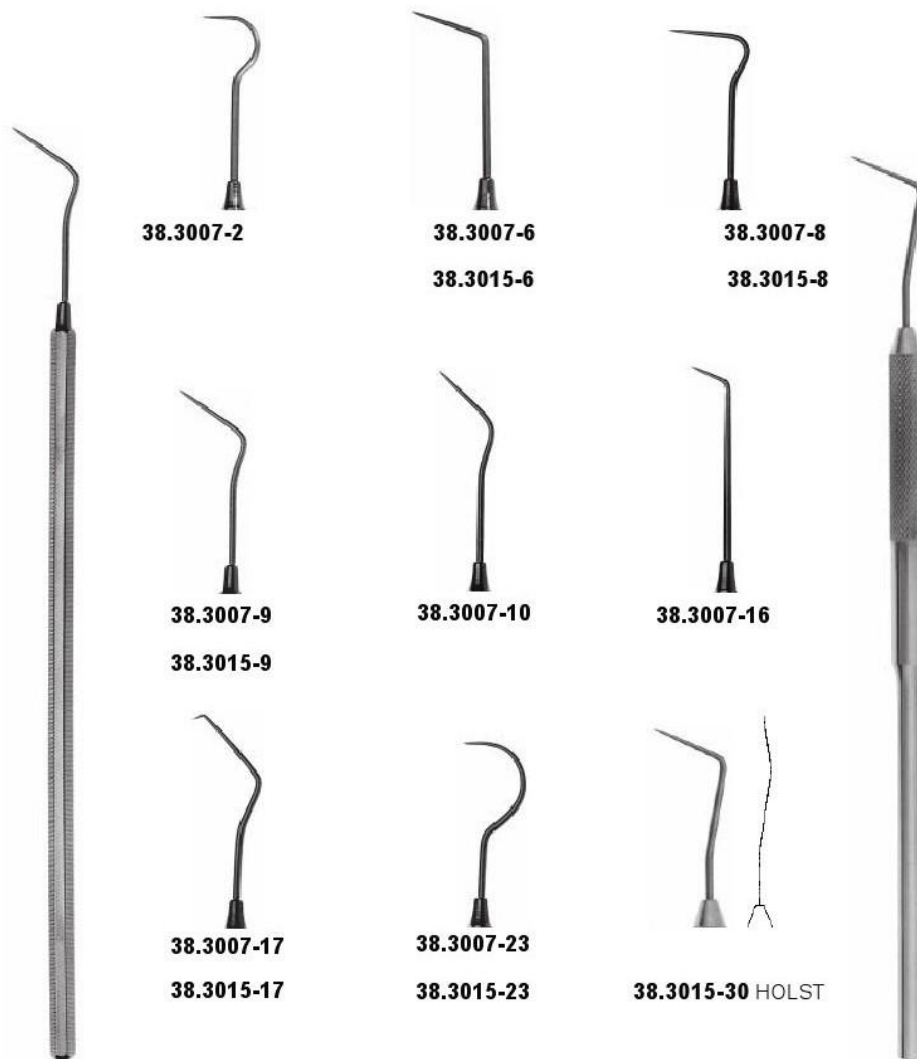

38

38.3007- UNIVERSAL
 Achtkantgriff, kräftige Spitzen
 Octagonal handle, strong tips
 Manche octagonal, pointes robustes
 Mango octagonal, puntas fuertes

38.3015- UNIVERSAL
 Rundgriff, kräftige Spitzen
 Round handle, strong tips
 Manche rond, pointes robustes
 Mango redondo, puntas fuertes

38

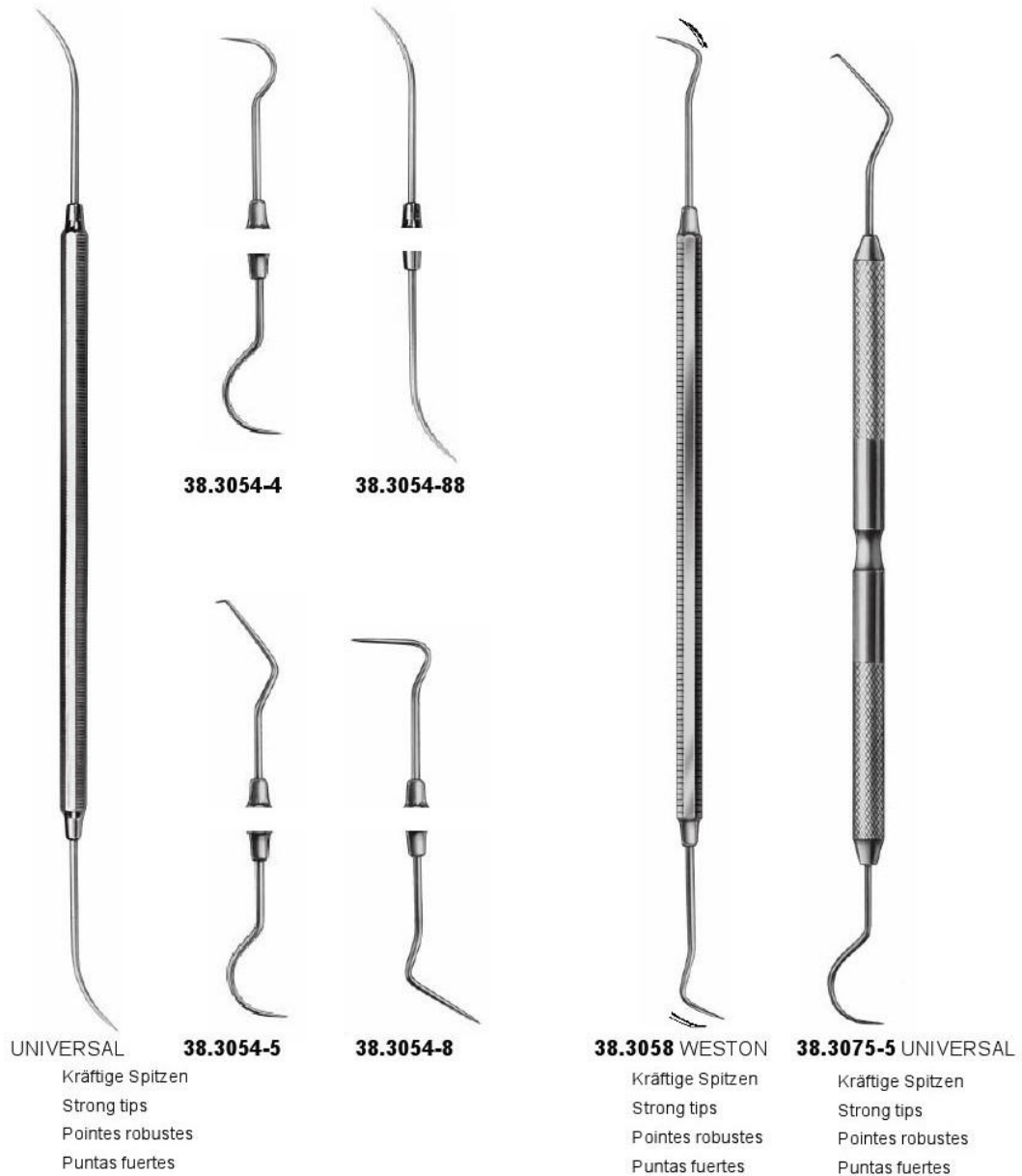

► **Extrem feine und flexible Spitzen**
aus einer Speziallegierung ermöglichen das Ertasten kleinster Defekte

► **Very delicate and flexible tips**
made from a special alloy allow for detection of smallest defects

► **Un bout très pointu et flexible**
fabriqué d'un alliage spécial permet la découverte des plus petits défauts

► **Puntas muy delgadas y flexibles**
fabricadas de una aleación especial facilitan el descubrimiento de defectos pequeños



OPTIFLEX

Sehr feine Spitzen
Very fine tips
Pointes très fines
Puntas muy finas



38.3016-8 OPTIFLEX



38.3016-9 OPTIFLEX



38.3016-17 OPTIFLEX



38.3016-23 OPTIFLEX

38

38

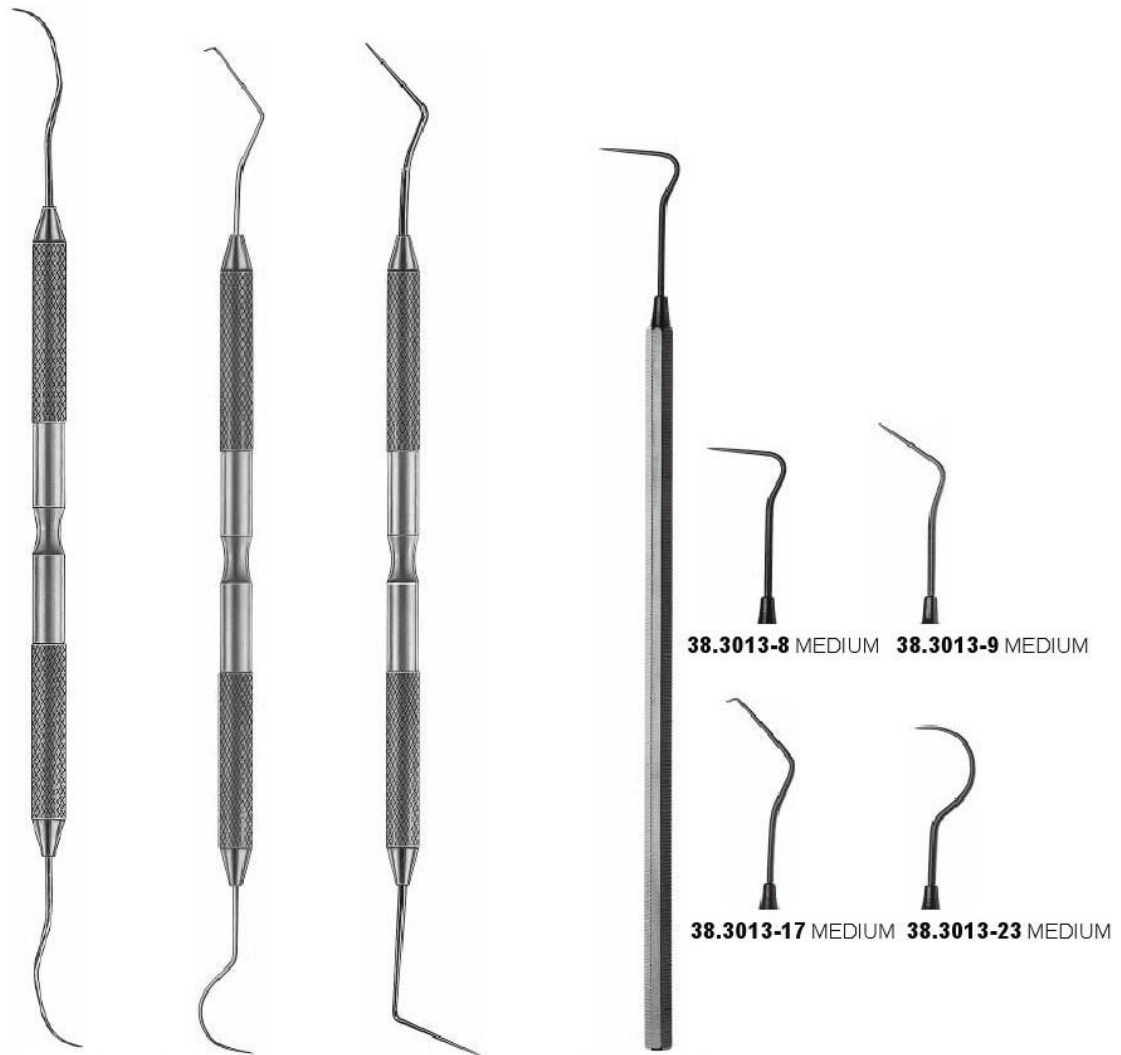

38.3074-110 OPTIFLEX

Sehr feine Spitzen
Very fine tips
Pointes très fines
Puntas muy finas

38.3074-5 OPTIFLEX

Sehr feine Spitzen
Very fine tips
Pointes très fines
Puntas muy finas

38.3078 OPTIFLEX

Wurzelkanal-Sonde
Root canal probe
Sonde à canaux
Sonda para conductos radiculares

MEDIUM

38.3013-8 MEDIUM

38.3013-9 MEDIUM

38.3013-17 MEDIUM

38.3013-23 MEDIUM

Mittelfeine Spitzen
Medium fine tips
Pointes mi-fines
Puntas semifinas

Parodontal-Sonden
 Periodontal probes
 Sondes parodontales
 Sondas paradontales



38

38.3077-2 NABERS
 Fig. Q2N

38.3076

38.3410 WHO

38.3410-1 WHO

38.3412 WILLIAMS

38.3418
 Fig. CP10

Parodontal-Sonden
Periodontal probes
Sondes parodontales
Sondas paradontales

38





39

PERIODONTIA
PARODONTOLOGIE
PARODONTOLOGIE
PERIODONCIA

ANWENDUNG KÜNRETTE

Oberkiefer
Upper jaw
Mâchoire supérieure
Maxilar superior

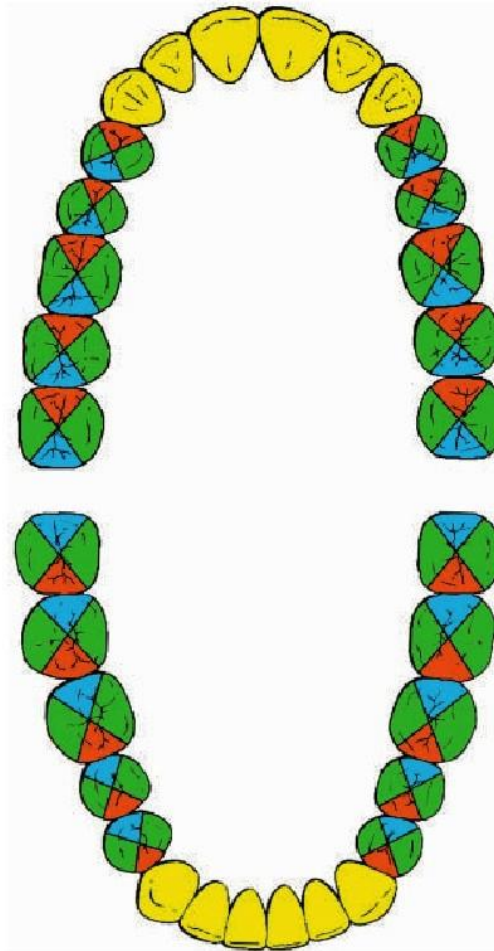

Unterkiefer
Lower jaw
Mâchoire inférieure
Maxilar inferior

39

- Fig. 1/2 oder Fig. 5/6
- Fig. 7/8 oder Fig. 9/10
- Fig. 11/12 oder Fig. 15/16
- Fig. 13/14 oder Fig. 17/18

Zahnreiner
Scalers
Instruments à détartrer
Limpiadores de sarro



39.3100-1



39.3100-2



39.3153

Fig. 6B



39.3168-4 HYGIENIST

Fig. H4



39.3168-5 HYGIENIST

Fig. H5



39.3100-3



39.3100-7



39.3154

Fig. 6D

39



39.3168-6 HYGIENIST

Fig. H6



39.3168-7 HYGIENIST

Fig. H7



39.3100-32



39.3144 THORPE

Zahnreiniger
 Scalers
 Instruments à détartrer
 Limpiadores de sarro

39



39.3169-1 HYGIENIST **39.3169-12** HYGIENIST
 Fig. H5



39.3169-6 HYGIENIST **39.3169-7** HYGIENIST
 Fig. H6 Fig. H7

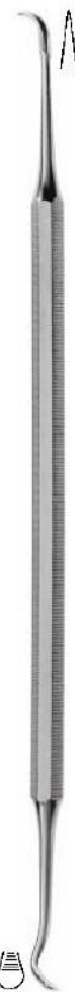

39.3253 CUMINE



39.3254 MITCHELL
 Osteotrimmer

Zahnreiner
 Scalers
 Instruments à détartrer
 Limpiadores de sarro

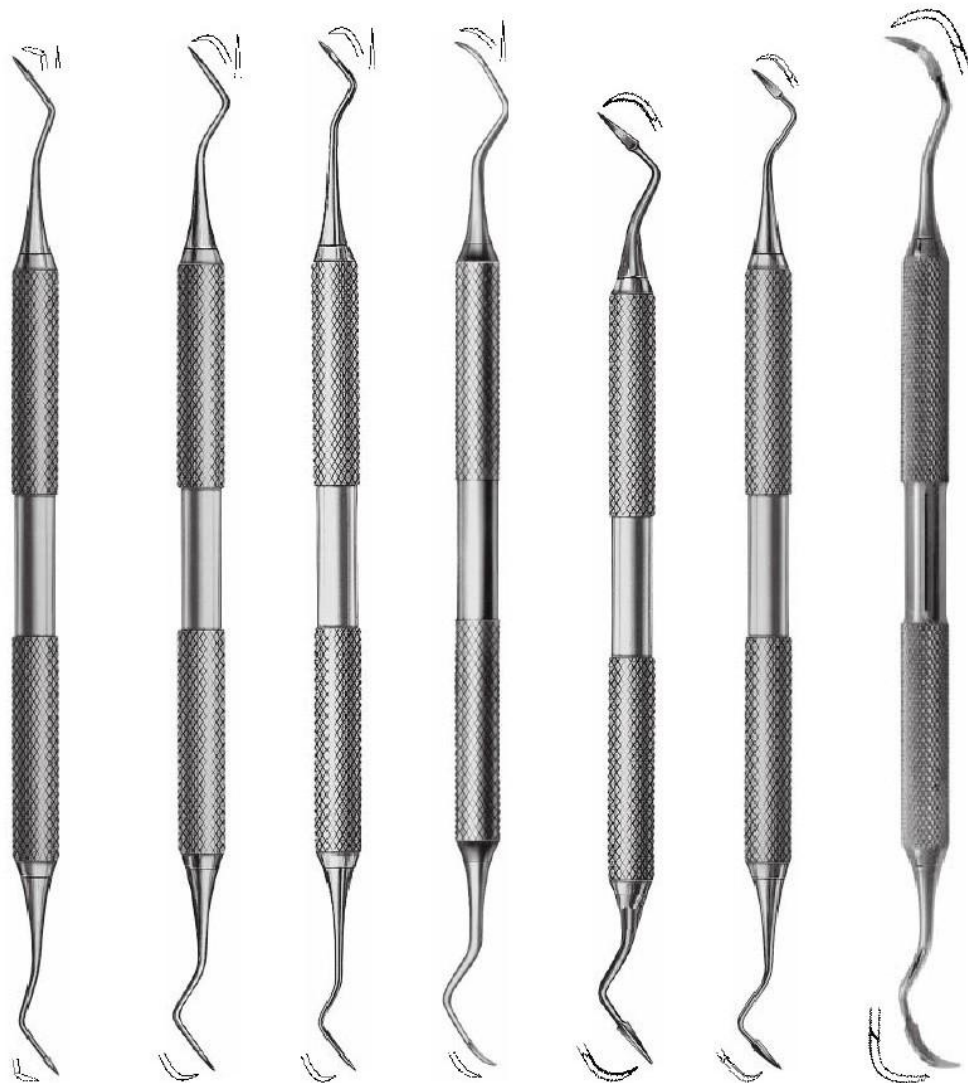

39

39.3274-1 JACQUETTE **39.3274-2** **39.3274-204** **39.3380-139** **39.3275** **39.3275-23 TAYLOR** **39.3276 CRANE-KAPLAN**
 Fig. 34/35 Fig. 204 S Fig. IU 13/14 Fig. 2/3 Fig. 2/3 Fig. 6

Zahnreiniger
 Scalers
 Instruments à détartrer
 Limpiadores de sarro

39

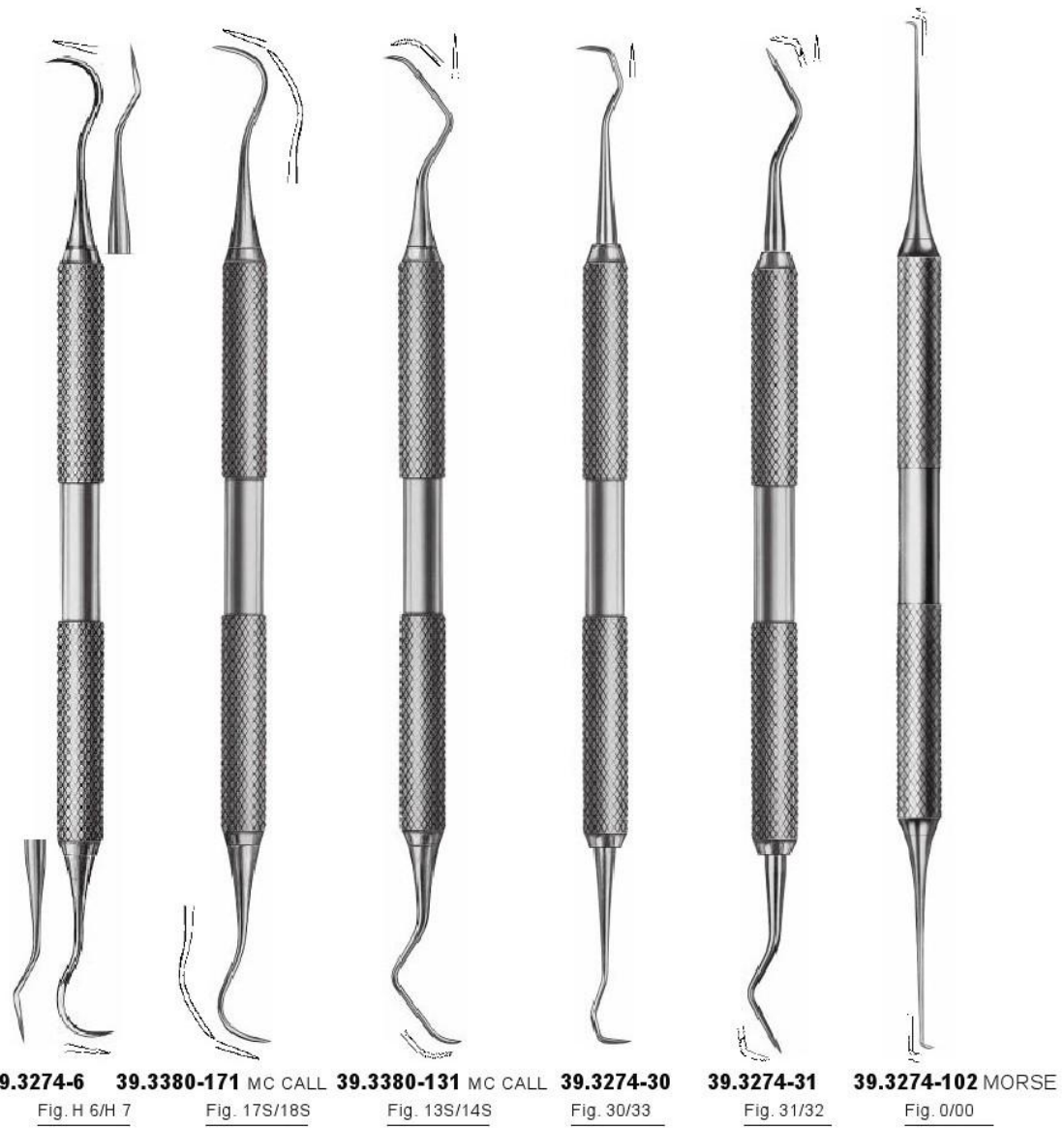

Zahnreineriger
Scalers
Instruments à détartrer
Limpiaadores de sarro



39

39.3376-1
Fig. GF1

39.3274-533
Fig. 5/33

39.3278 TOWNER
Fig. U 15/30

39.3376-5
Fig. GF5

39.3376-6
Fig. GF6

39.3383
Fig. GF10

Küretten mit Farbring
 Curettes with colour ring
 Curettes avec anneaux de couleurs
 Curetas con anillo del color

39



GRACEY



39.3374-1 GRACEY

Fig. 1/2

1 - 3



39.3374-3 GRACEY

Fig. 3/4

1 - 5



39.3374-5 GRACEY

Fig. 5/6

1 - 5



39.3374-7 GRACEY

Fig. 7/8

lingual + buccal

4 - 8



39.3374-9

Fig. 9/10

lingual + buccal

4 - 8



39.3374-11

Fig. 11/12

mesial

4 - 8



39.3374-13

Fig. 13/14

distal

4 - 8



39.3374-15

Fig. 15/16

mesial

4 - 8



39.3374-17

Fig. 17/18

distal

4 - 8

Farbringe für GRACEY Küretten
 Colour rings for GRACEY curettes
 Anneaux de couleurs pour GRACEY curettes
 Anillo del color para GRACEY curetas

- ▶ Zur Kodierung der Instrumente mit Farbringen
- ▶ 9 Farben
- ▶ Sterilisierbar bis zu 170°C (338°F)
- ▶ Hergestellt aus Silikon

- ▶ For color-coding instruments
- ▶ 9 colors
- ▶ Sterilizable up to 170°C (338°F)
- ▶ Made of silicone rubber

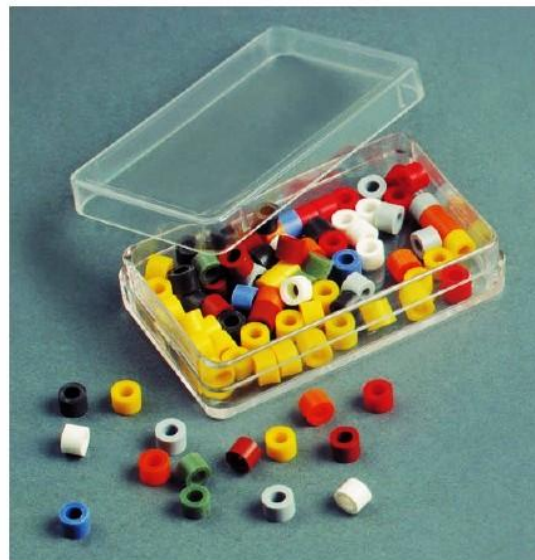

39

-  **39.3360-1** grau/grey
P. of 50 pcs.
-  **39.3360-3** schwarz/black
P. of 50 pcs.
-  **39.3360-5** gelb/yellow
P. of 50 pcs.
-  **39.3360-7** grün/green
P. of 50 pcs.
-  **39.3360-9** rot/red
P. of 50 pcs.
-  **39.3360-11** orange/orange
P. of 50 pcs.
-  **39.3360-13** blau/blue
P. of 50 pcs.
-  **39.3360-15** braun/brown
P. of 50 pcs.
-  **39.3360-17** weiss/white
P. of 50 pcs.

Küretten
Curettes
Curettes
Curetas

39



GRACEY

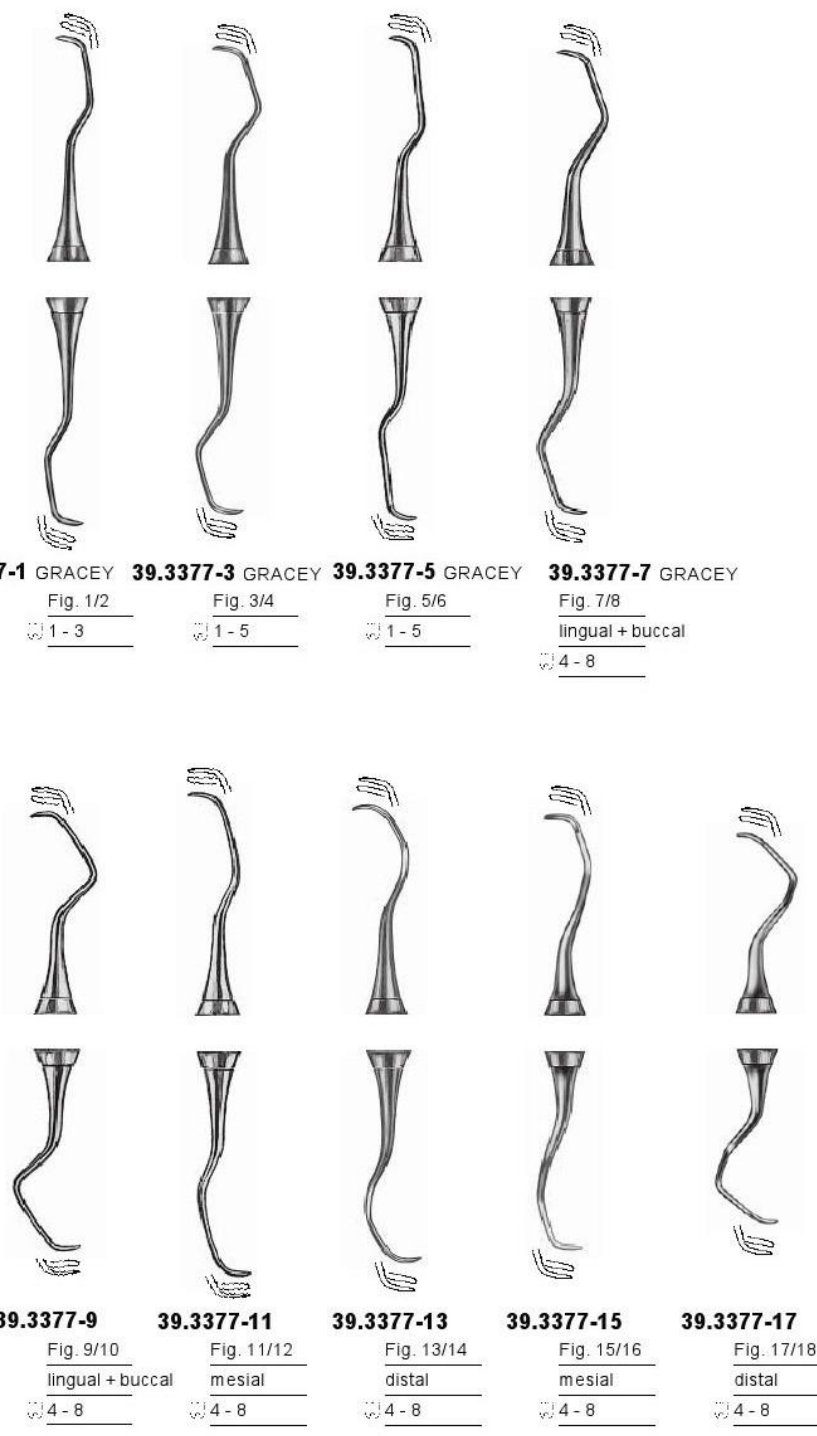

39.3377-1 GRACEY Fig. 1/2
1 - 3

39.3377-3 GRACEY Fig. 3/4
1 - 5

39.3377-5 GRACEY Fig. 5/6
1 - 5

39.3377-7 GRACEY Fig. 7/8
lingual + buccal
4 - 8

39.3377-9 GRACEY Fig. 9/10
lingual + buccal
4 - 8

39.3377-11 GRACEY Fig. 11/12
mesial
4 - 8

39.3377-13 GRACEY Fig. 13/14
distal
4 - 8

39.3377-15 GRACEY Fig. 15/16
mesial
4 - 8

39.3377-17 GRACEY Fig. 17/18
distal
4 - 8



39.3375-5 GRACEY COLOR

Fig. 5/6

1 - 5



39.3375-7 GRACEY COLOR

Fig. 7/8

lingual + buccal

4 - 8

39



39.3375-11 GRACEY COLOR

Fig. 11/12

mesial

4 - 8



39.3375-13 GRACEY COLOR

Fig. 13/14

distal

4 - 8

Für tiefe Taschen, Miniatur
 For deep pockets, Miniatur
 Pour poches profondes, Miniature
 Para bolsas profundas, Miniatur

39

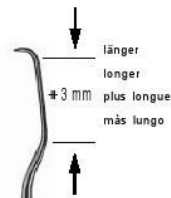

GRACEY
 miniatur

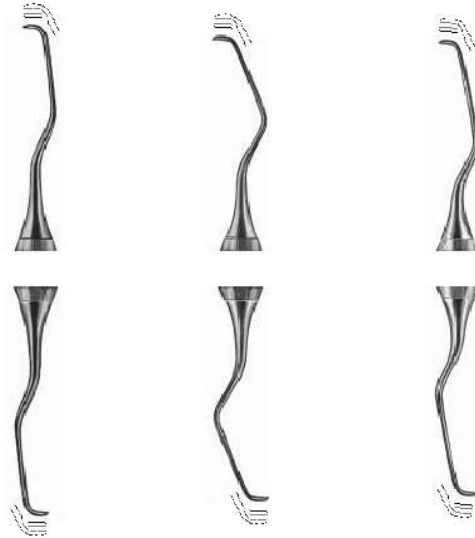

39.3377-101 GRACEY
 Fig. 1/2, miniatur
 1 - 3

39.3377-103 GRACEY
 Fig. 3/4, miniatur
 1 - 5

39.3377-105 GRACEY
 Fig. 5/6, miniatur
 1 - 5

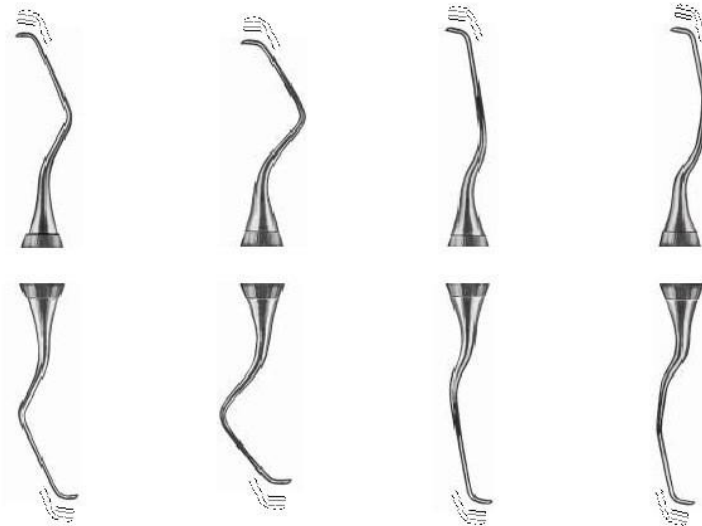

39.3377-107
 Fig. 7/8, miniatur
 lingual + buccal
 4 - 8

39.3377-109
 Fig. 9/10, miniatur
 lingual + buccal
 4 - 8

39.3377-111
 Fig. 11/12, miniatur
 mesial
 4 - 8

39.3377-113
 Fig. 13/14, miniatur
 distal
 4 - 8

Furchungsküretten
Curettes for root depressions
Curettes pour dépressions radicaire
Curetas para depresiones en la raiz

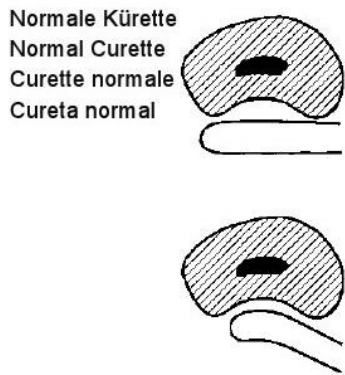

- ▶ Optimale Reinigung/Glättung vertikaler Wurzeleinziehungen
- ▶ Optimal planing of vertical depressions on root surfaces
- ▶ Curettage optimal de dépressions verticales sur la surface des racines
- ▶ Óptima limpieza de contracciones verticales en la superficie de la raiz



39.3372-11 GEURTSSEN-GÜNAY

Fig. 11/12
 mesial
 4 - 8

39.3372-13 GEURTSSEN-GÜNAY

Fig. 13/14
 distal
 6 - 8

Universalküretten
 Universal curettes
 Curettes universelles
 Curetas universales

39

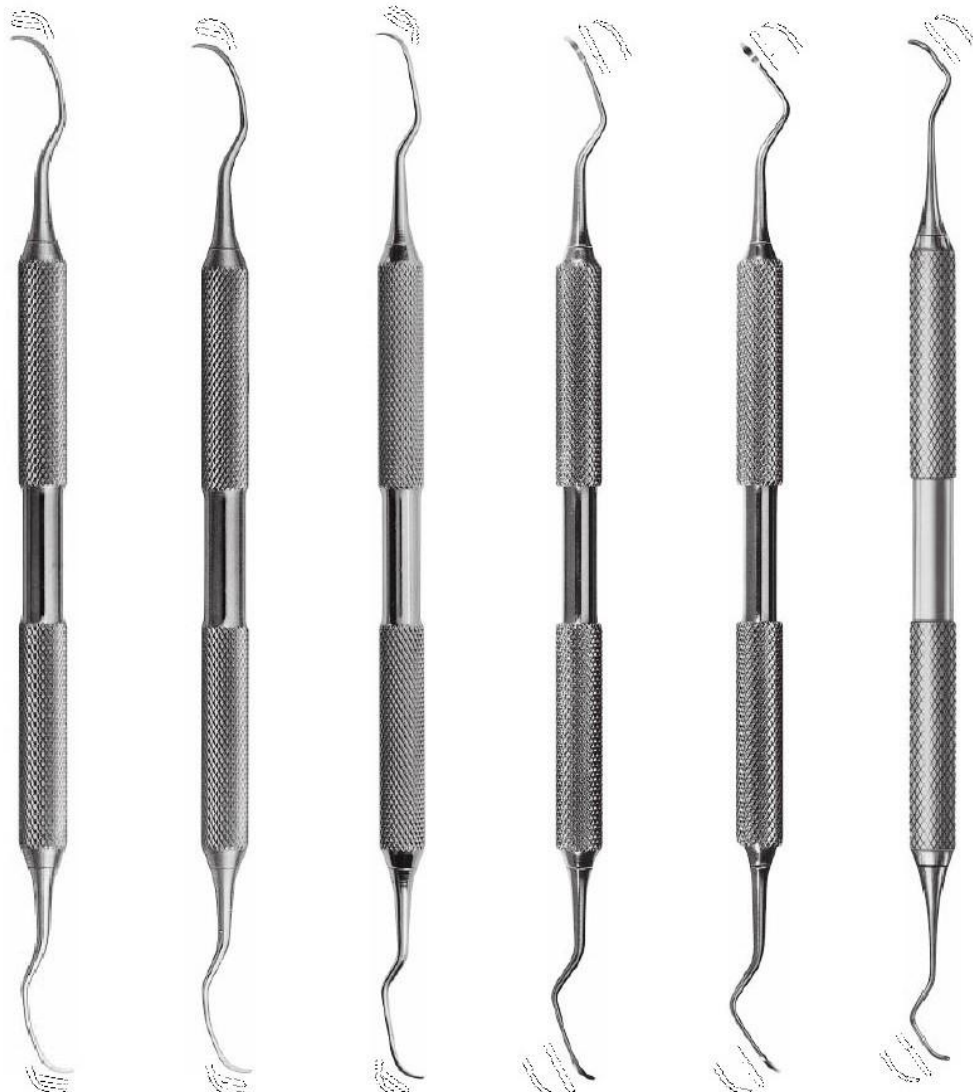

39.3377-91 LANGER	39.3377-93 LANGER	39.3377-95 LANGER	39.3379-2 COLUMBIA	39.3379-4 COLUMBIA	39.3379-13 COLUMBIA
Fig. L 1/2	Fig. L 3/4	Fig. L 5/6	Fig. 2L/2R	Fig. 4L/4R	Fig. 13/14
34 - 38 44 - 48	14 - 18 24 - 28	1 - 3	1 - 5	6 - 8	6 - 8 Wurzeln· roots racines· raíces



39

- ▶ Schnellwechsel ohne Werkzeug
- ▶ Spitzen stehen automatisch in richtiger Position
- ▶ Abgedichteter Verschluß

- ▶ Fast tip change without tools
- ▶ Tips are automatically aligned in correct position
- ▶ Sealed closure

- ▶ Remplacement rapide des points sans aucun outil
- ▶ Pointes tenues toujours en position correcte
- ▶ Fermeture étanchée

- ▶ Rápido cambio sin utensilios
- ▶ Puntas siempre alineadas en posición correcta
- ▶ Atornillado empaquetado

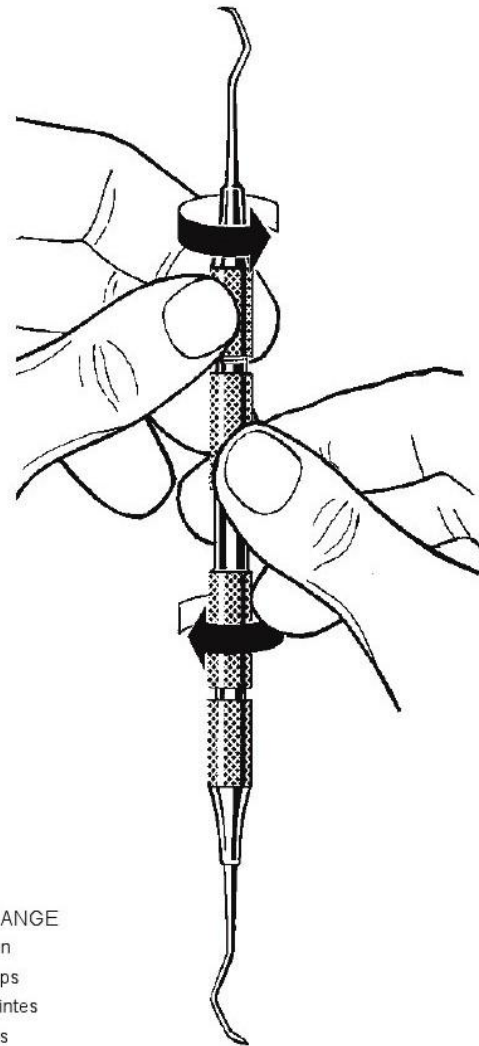

39.3330 QUICK-CHANGE

Griff ohne Spitzen
 Handle without tips
 Manche sans pointes
 Mango sin puntas



39.3334-6 HYGIENIST

Fig. H6
 Spitze · tip · pointe
 punta



39.3334-7 HYGIENIST

Fig. H7
 Spitze · tip · pointe
 punta



39.3334-22

Fig. 2
 Spitze · tip · pointe
 punta



39.3334-23

Fig. 3
 Spitze · tip · pointe
 punta

QUICK-CHANGE



39.3347-5 GRACEY
Fig. 5
Spitze · tip · pointe
punta



39.3347-6 GRACEY
Fig. 6
Spitze · tip · pointe
punta



39.3347-7 GRACEY
Fig. 7
Spitze · tip · pointe
punta



39.3347-8 GRACEY
Fig. 8
Spitze · tip · pointe
punta

39



39.3347-11 GRACEY
Fig. 11
Spitze · tip · pointe
punta



39.3347-12 GRACEY
Fig. 12
Spitze · tip · pointe
punta



39.3347-13 GRACEY
Fig. 13
Spitze · tip · pointe
punta



39.3347-14 GRACEY
Fig. 14
Spitze · tip · pointe
punta



39.3340-13 MC CALL
Fig. 13
Spitze · tip · pointe
punta



39.3340-14 MC CALL
Fig. 14
Spitze · tip · pointe
punta



39.3340-17 MC CALL
Fig. 17
Spitze · tip · pointe
punta



39.3340-18 MC CALL
Fig. 18
Spitze · tip · point
punta

Parodontalmesser
 Gingivectomy knives
 Bistouris pour la gingivectomie
 Bisturías para la gingivectomía

39



39.3395 KIRKLAND
 Fig. 15K/16K



39.3396
 Fig. GF7



39.3397
 Fig. GF8



39.3398
 Fig. GF11



39.3399 ORBAN
 Fig. 1/2



39.3399-2 ORBAN
 Fig. 3/4

Zur Gewebeerntfernung
 For removing tissue
 Pour retirer le tissu
 Para quitar el tejido

Feilen
 Files
 Limes
 Limas

Gewebezangchen
 Tissue nippers
 Pincers  couper le tissue
 Pinzas para cortar tejidos



39.3378
 Fig. GF9



39.3232 HIRSCHFELD
 Fig. 3/7



39.3232-2 HIRSCHFELD
 Fig. 5/11



39.3233-9 SCHLUGER
 Fig. 9/10



39.3438-10 COHEN
 10 cm

39.3438-16 SUGARMAN
 16 cm



39.3439-10 COHEN
 10 cm

39.3439-13 ILIC
 13 cm

39

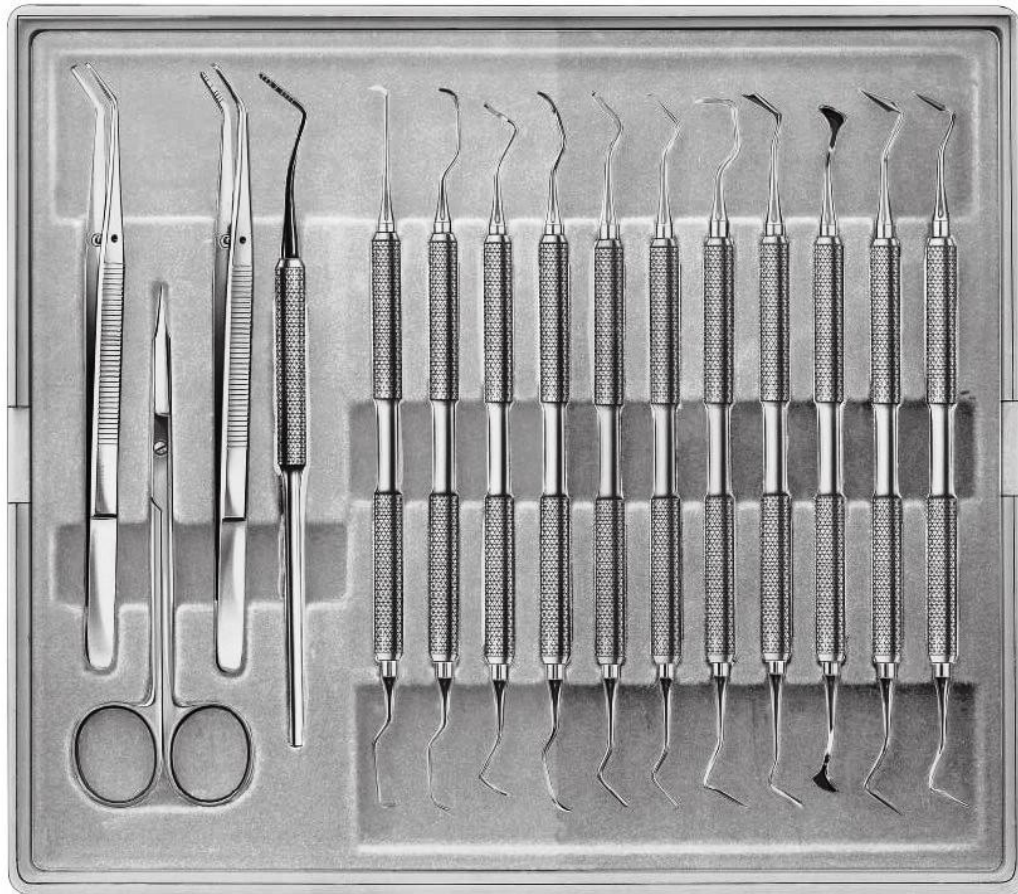

39.3426-1 + 39.3426-2

39.1117

39.3418 -1 -2

39.3376-

-3 -4 -5 -6

39.3378

39.3383

39.3396

39.3397

39.3398

39.3382 GOLDMANN-FOX- SET

kompletter Sat

complete set

jeu complet

estuche completo

- ▶ Preiswerter Schutz von PA-Instrumenten
- ▶ Geeignet für alle üblichen Hygieneverfahren
- ▶ Paßt genau in Normtrays

- ▶ Economical protection of periodontal instruments
- ▶ Suited for all common hygienical processes
- ▶ Fits exactly into standard trays

- ▶ Protection économique d'instruments parodontaux
- ▶ Propre à toute procedure hygiénique usuelle
- ▶ Mésures ajustées au plateau standards

- ▶ Protección de instrumentos parodontales a buen precio
- ▶ Propio para toda operación higiénica usual
- ▶ Proporciones ajustadas para estuches estandard

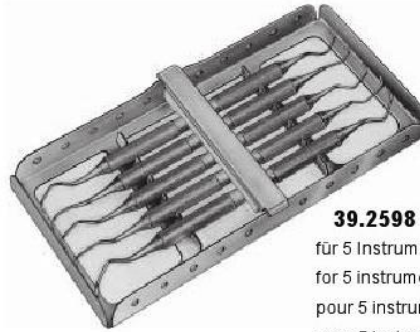

39.2598 PROTECTOR

für 5 Instrumente, 3 Rahmen pro Normtray
for 5 instruments, 3 racks per standard tray
pour 5 instruments, 3 cadres par plateau standar
para 5 instrumentos, 3 cuadros por estuches estandard



39.2598-10 PROTECTOR

für 10 Instrumente, 2 Rahmen pro Normtray
for 10 instruments, 2 racks per standard tray
pour 10 instruments, 2 cadres par plateau standard
para 10 instrumentos, 2 cuadros por estuches estandard

39



39.1700-510

für 22 Instrumente, 275 x 175 x 25 mm
for 22 instruments, 275 x 175 x 25 mm
pour 22 instruments, 275 x 175 x 25 mm
para 22 instrumentos, 275 x 175 x 25 mm



40

CONSERVATIVE
KONSERVIERENDE
CONSERVATRICE
CONSERVACIÓN

Schmelzmeißel
Enamel chisels
Ciseaux à émail
Cinceles para esmalte

Gingivalrandschräger
Gingival margin trimmers
Finisseurs à bords gingivaux
Recortadores del margen gingival

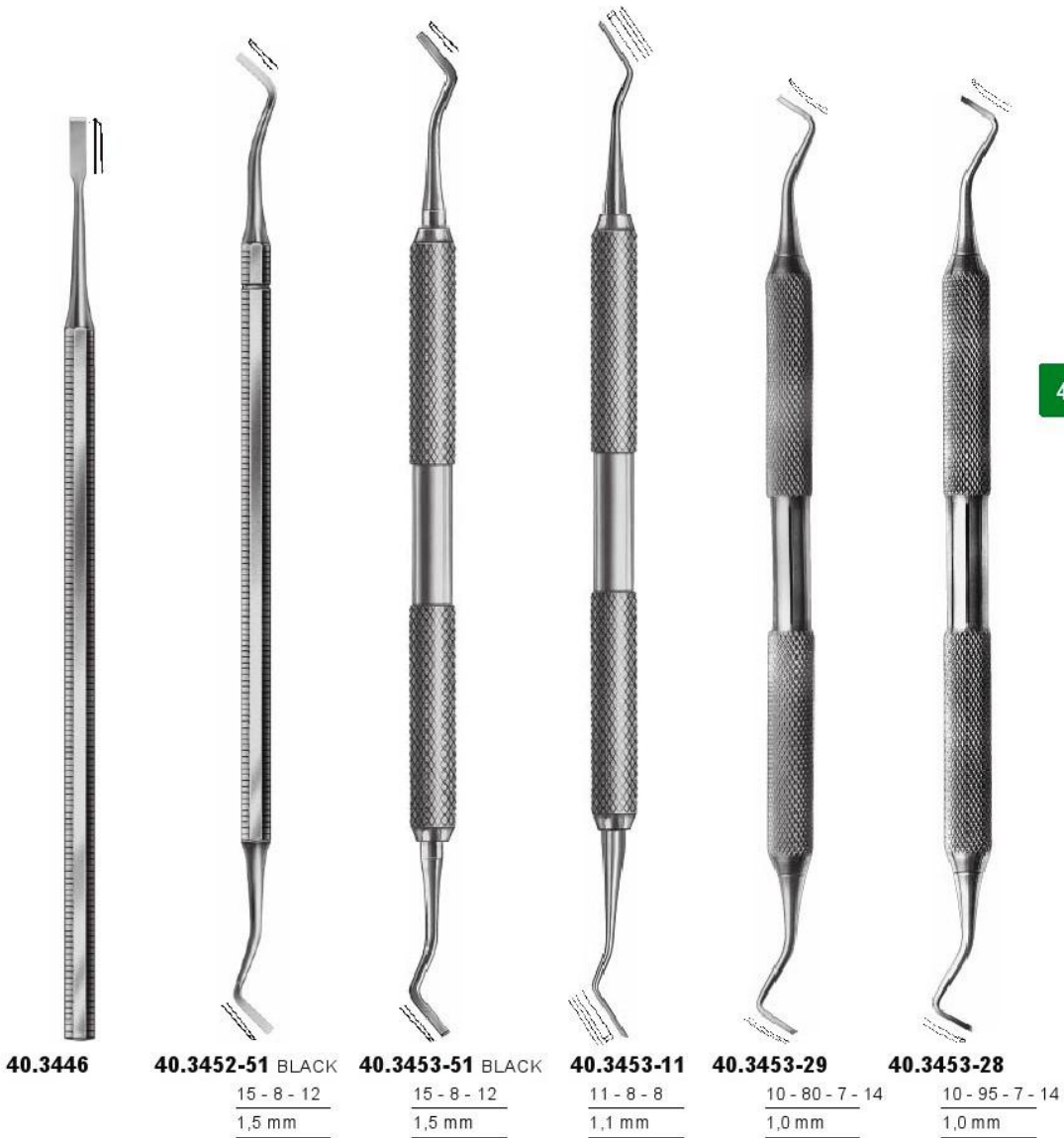

40

Gingivalrandschräger
 Gingival margin trimmers
 Finisseurs à bords gingivaux
 Recortadores del margen gingival

40

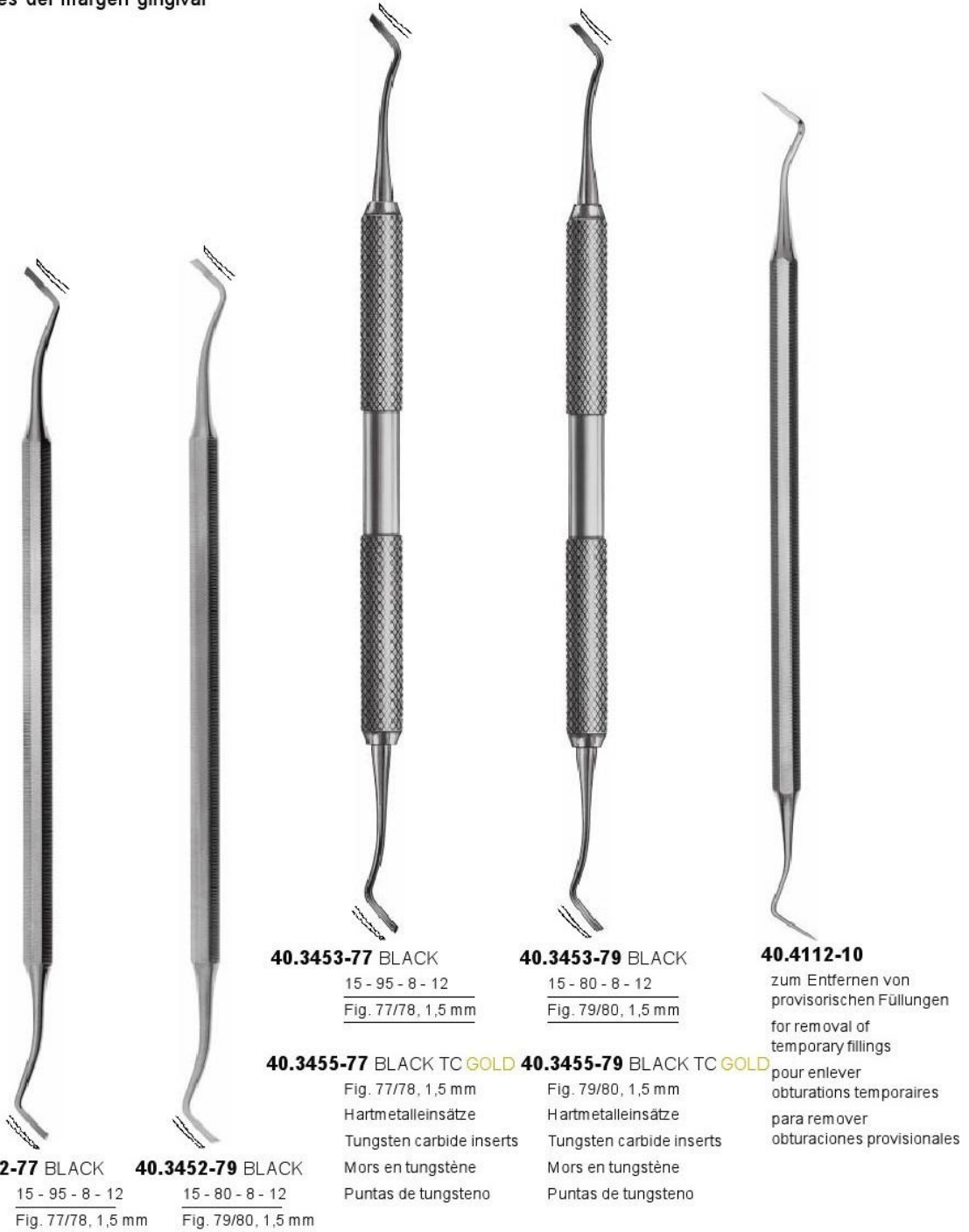

40.3452-77 BLACK **40.3452-79 BLACK**
 15 - 95 - 8 - 12 15 - 80 - 8 - 12
 Fig. 77/78, 1,5 mm Fig. 79/80, 1,5 mm

40.3453-77 BLACK
 15 - 95 - 8 - 12
 Fig. 77/78, 1,5 mm

40.3453-79 BLACK
 15 - 80 - 8 - 12
 Fig. 79/80, 1,5 mm

40.3455-77 BLACK TC GOLD **40.3455-79 BLACK TC GOLD**
 Fig. 77/78, 1,5 mm Fig. 79/80, 1,5 mm
 Hartmetalleinsätze Hartmetalleinsätze
 Tungsten carbide inserts Tungsten carbide inserts
 Mors en tungstène Mors en tungstène
 Puntas de tungsteno Puntas de tungsteno

40.4112-10
 zum Entfernen von
 provisorischen Füllungen
 for removal of
 temporary fillings
 pour enlever
 obturations temporaires
 para remover
 obturaciones provisionales

Exkavatoren
Excavators
Excavateurs
Excavadores

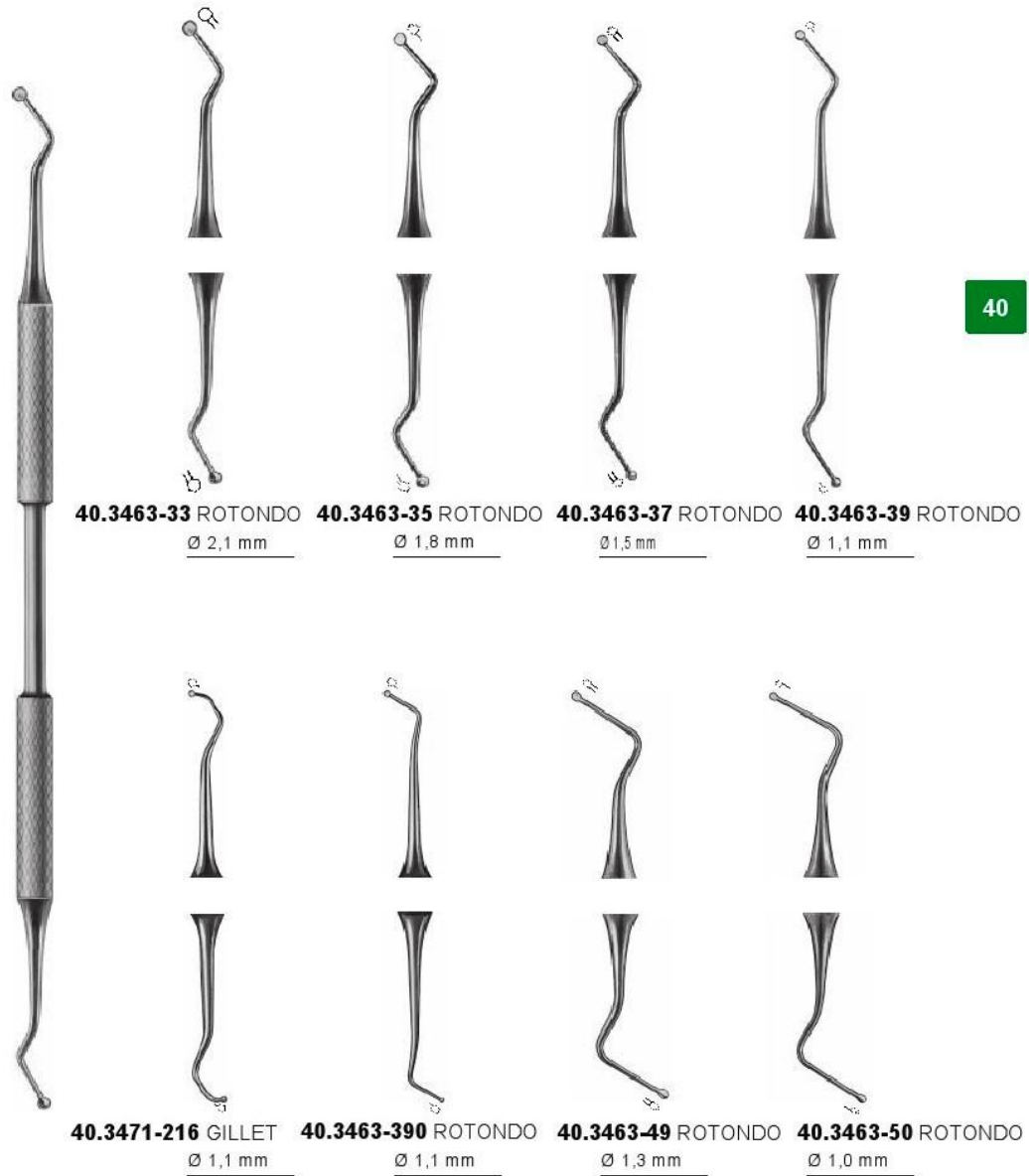

40

Exkavatoren
Excavators
Excavateurs
Excavadores

40

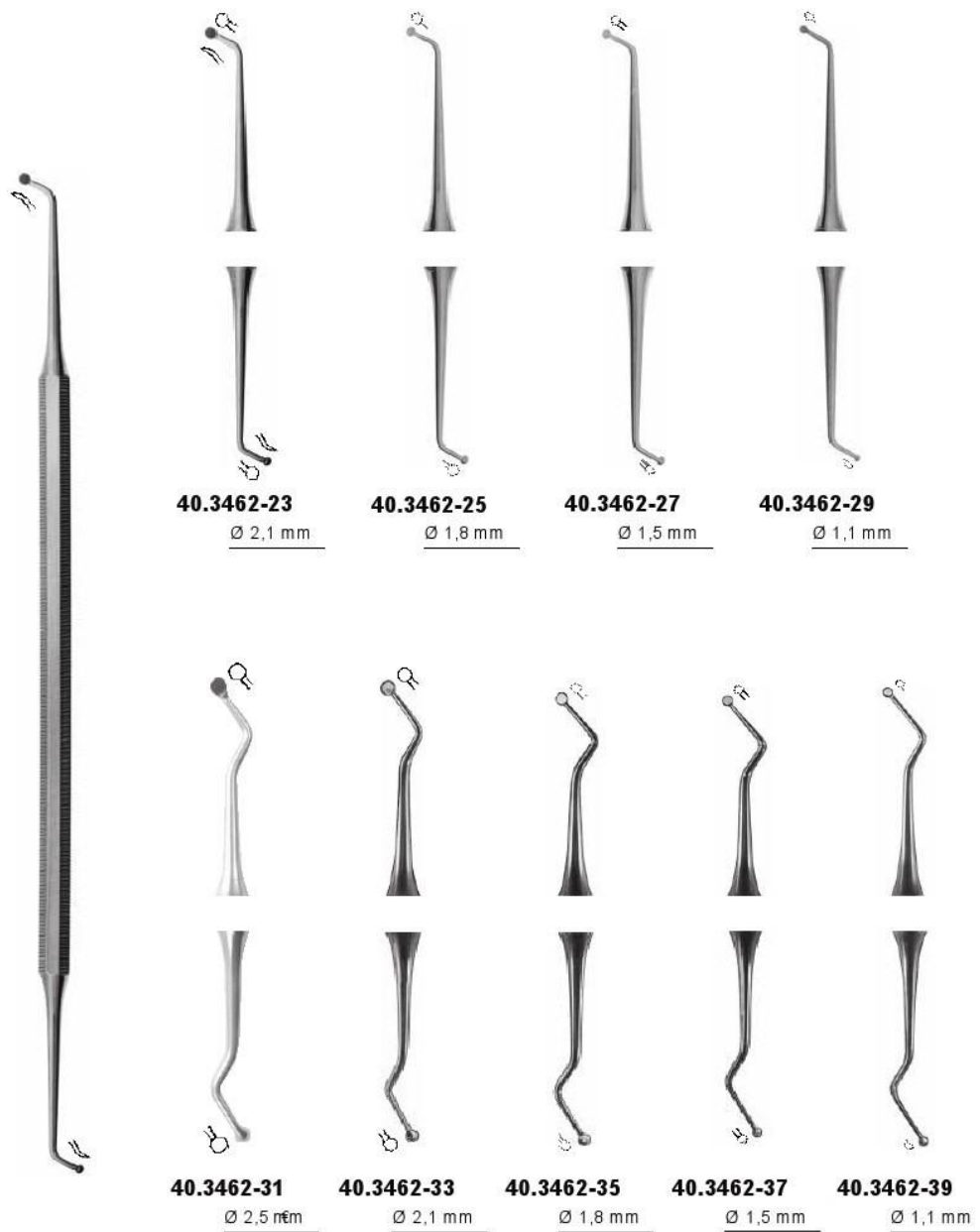

Exkavatoren
Excavators
Excavateurs
Excavadores

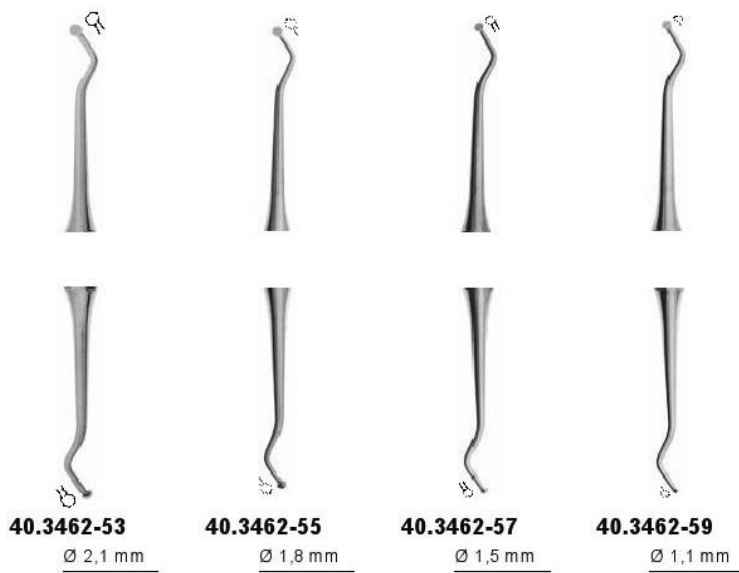
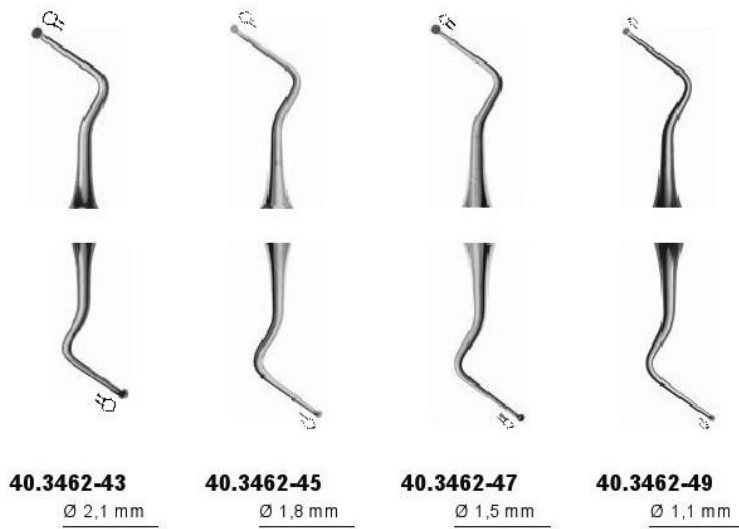

Exkavatoren
Excavators
Excavateurs
Excavadores

40

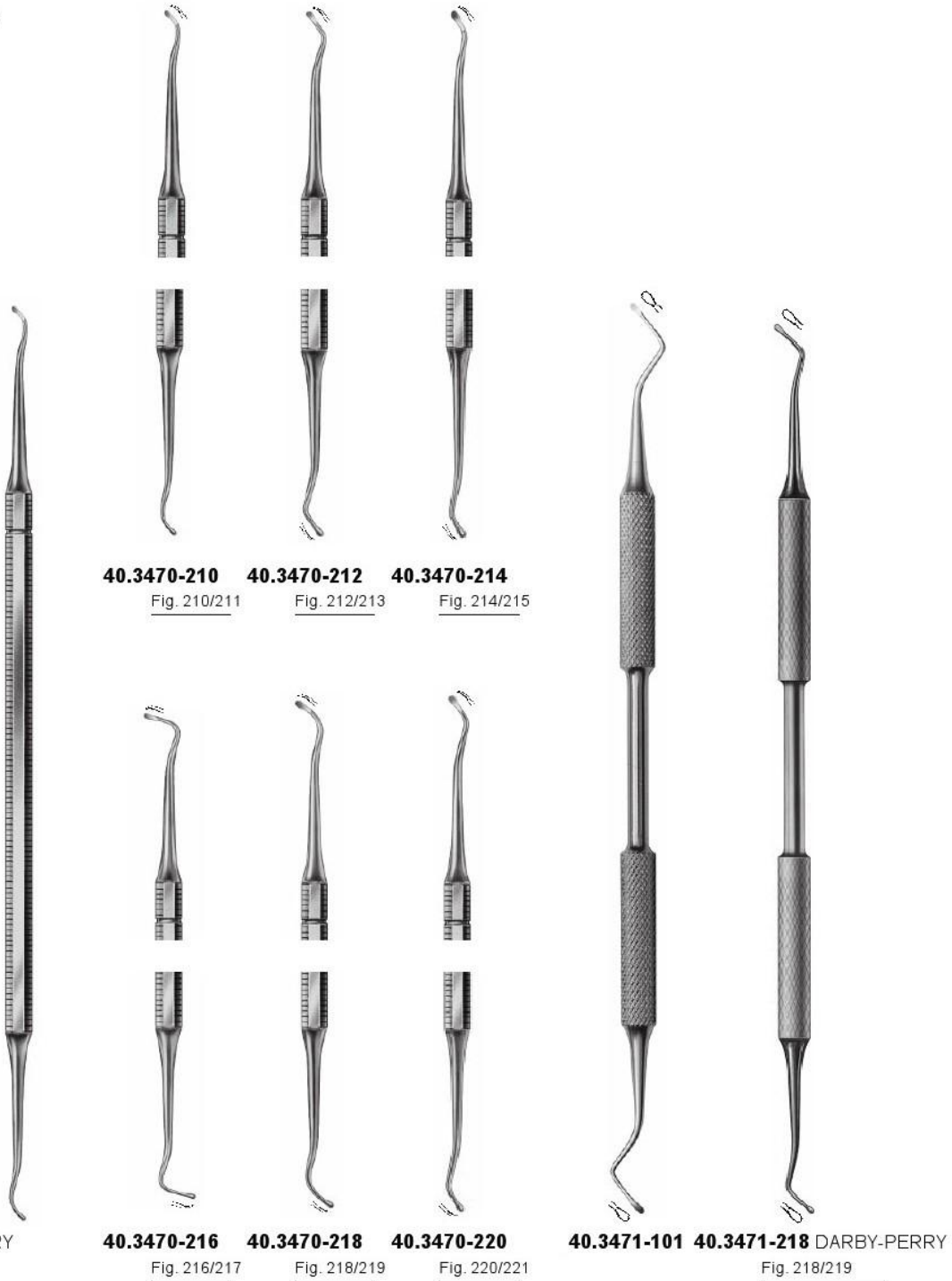

DARBY-PERRY

40.3470-216

40.3470-218

40.3470-220

40.3471-101

40.3471-218

DARBY-PERRY

Exkavatoren
Excavators
Excavateurs
Excavadores

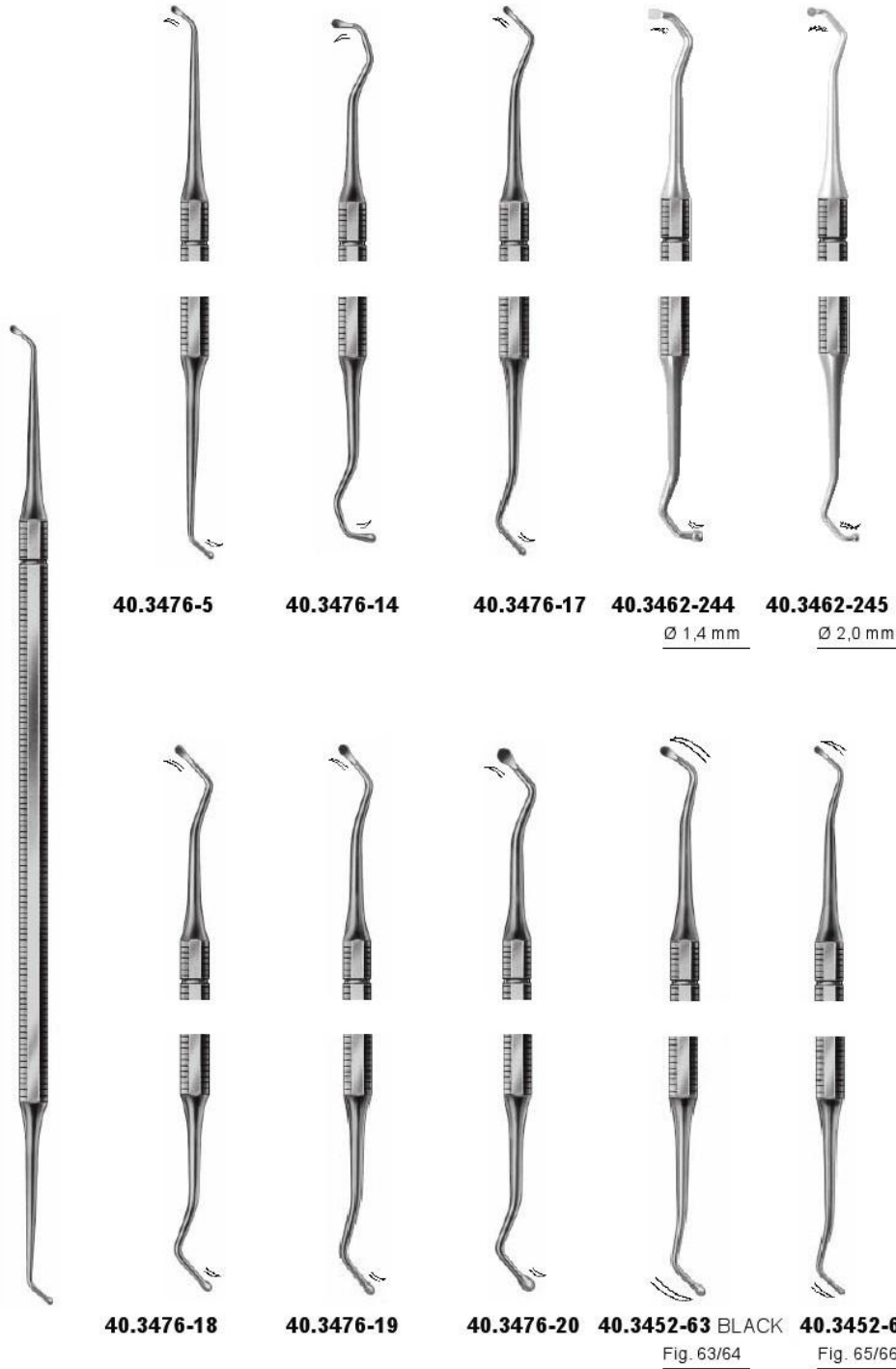

40

matrizenspanner una matrizen
 Matrix retainers and matrixes
 Porte-Matrices et matrices
 Portamatrices y matrices

40



40.3581 IVORY



40.3582 IVORY



40.3583



40.3605 IVORY

Separator
 Separator
 Séparateur
 Separador



40.3585 FIG. 8
5 mm



40.3588-1 NYSTRÖM
6 mm



40.3588-2
6 mm



40.3590 TOFFLEMIRE
Universal



40.3590-1
Junior



40.3590-2
Senior

40.3587 FIG. 8
7 mm

**Amalgampistolen
Amalgam carriers
Porte-amalgames
Porta amalgamas**



40.3760

Stößel für Amalgampistolen
Replacement plunger for amalgam carriers
Poussoir pour porte-amalgames
Émbolo para porta amalgamas

bis 140°C sterilisierbar
sterilisation up to 140°C
stérilisables jusqu'à 140°C
esterilización hasta 140°C



40

40.3761

15 cm

40.3761-1

Ersatzspitzen aus Metall
Metal replacement tips
Pointes de rechange en métal
Puntas de recambio de metal



40.3762

15 cm

40.3762-1

Ersatzspitzen aus Kunststoff
Plastic replacement tips
Pointes de rechange en plastique
Puntas de recambio de plástico



40.3765

13 cm

40.3765-1

Ersatzspitzen aus Metall
Metal replacement tips
Pointes de rechange en métal
Puntas de recambio de metal



40



40.3767

18 cm

40.3767-1



Ersatzspitzen aus Kunststoff
 Plastic replacement tips
 Pointes de rechange en plastique
 Puntas de recambio de plástico



40.3768 IVORY

16 cm

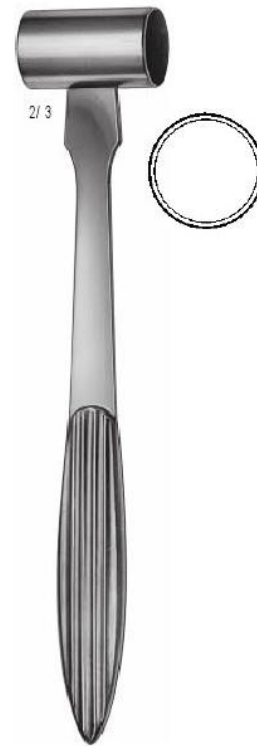

40.3740

Plombierhammer, 19 cm, 180 g, bleigefüllt
 Plugging mallet, 19 cm, 180 g, lead filled
 Maillet pour aurification, 19 cm, 180 g, rempli de plomb
 Martillo para orificaciones, 19 cm, 180 g, relleno de plomo

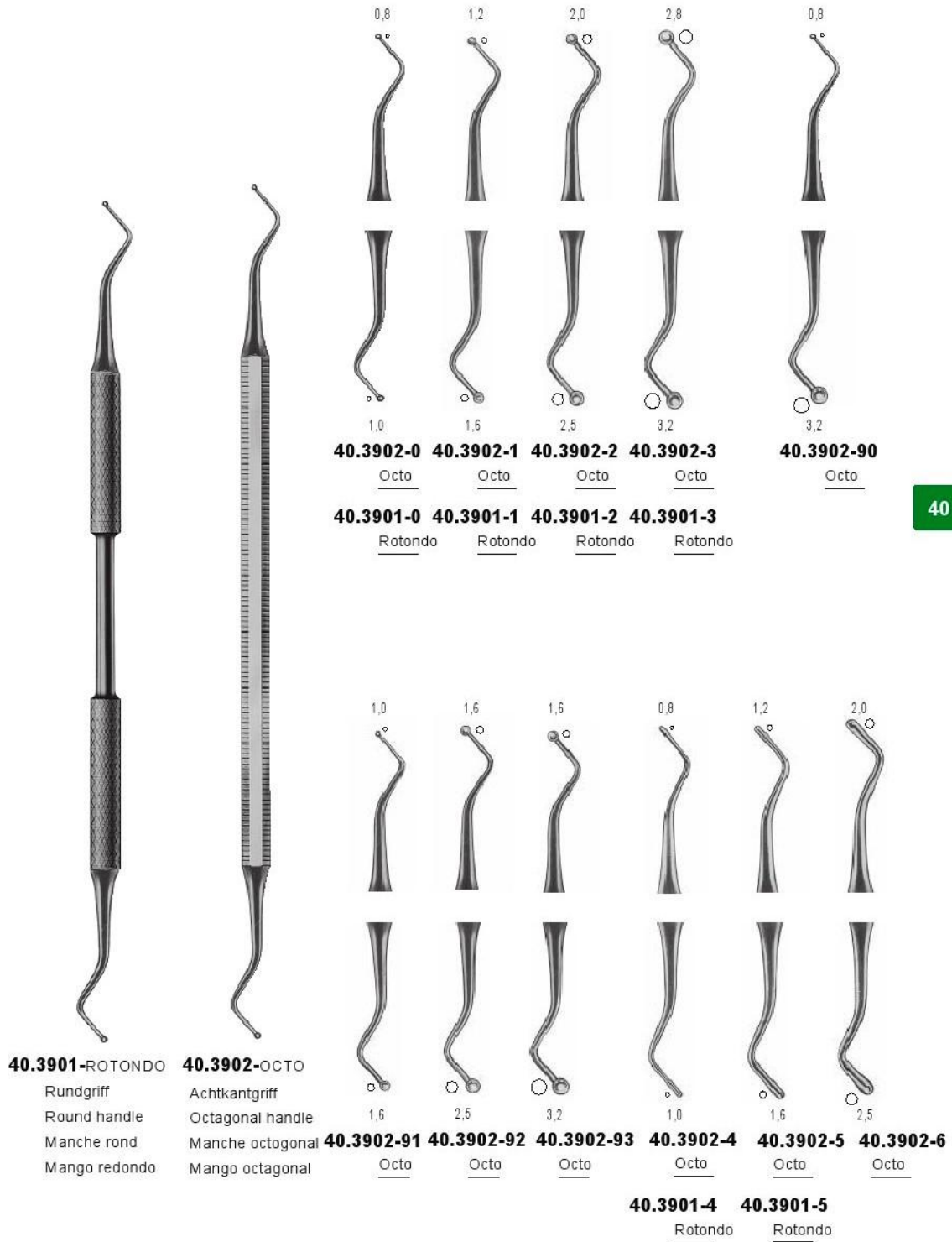

40

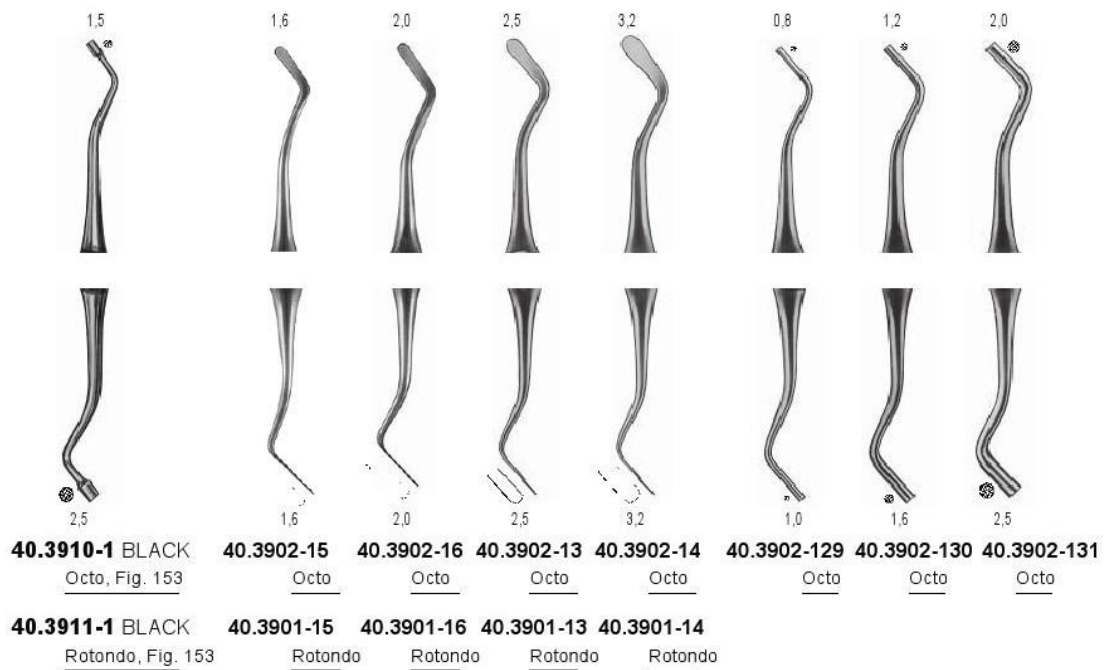
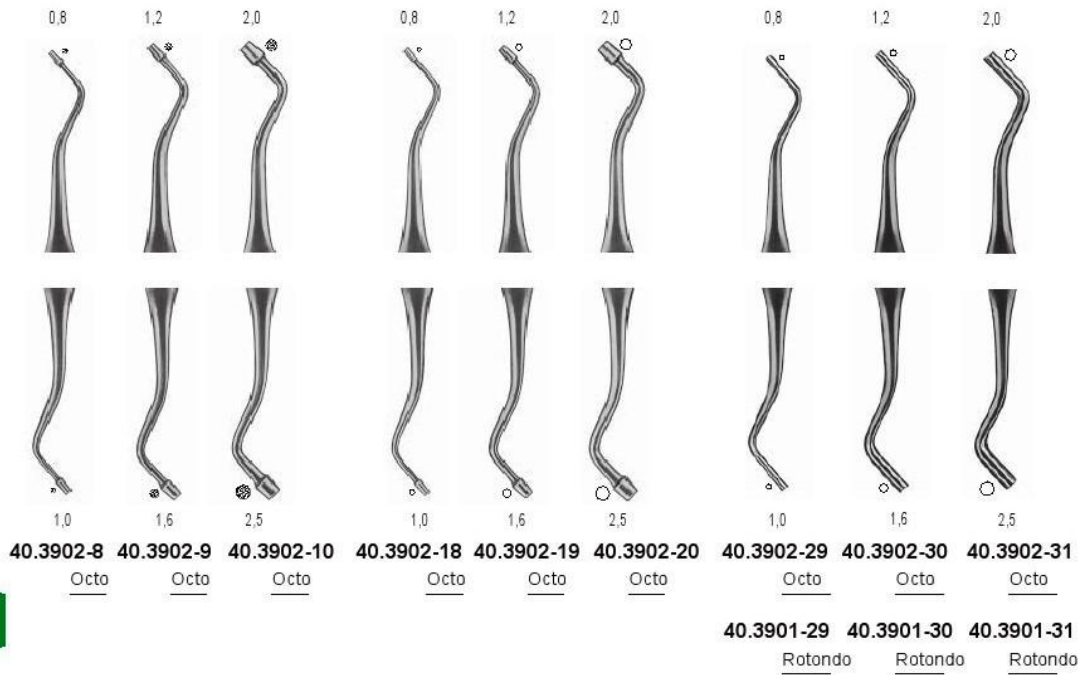

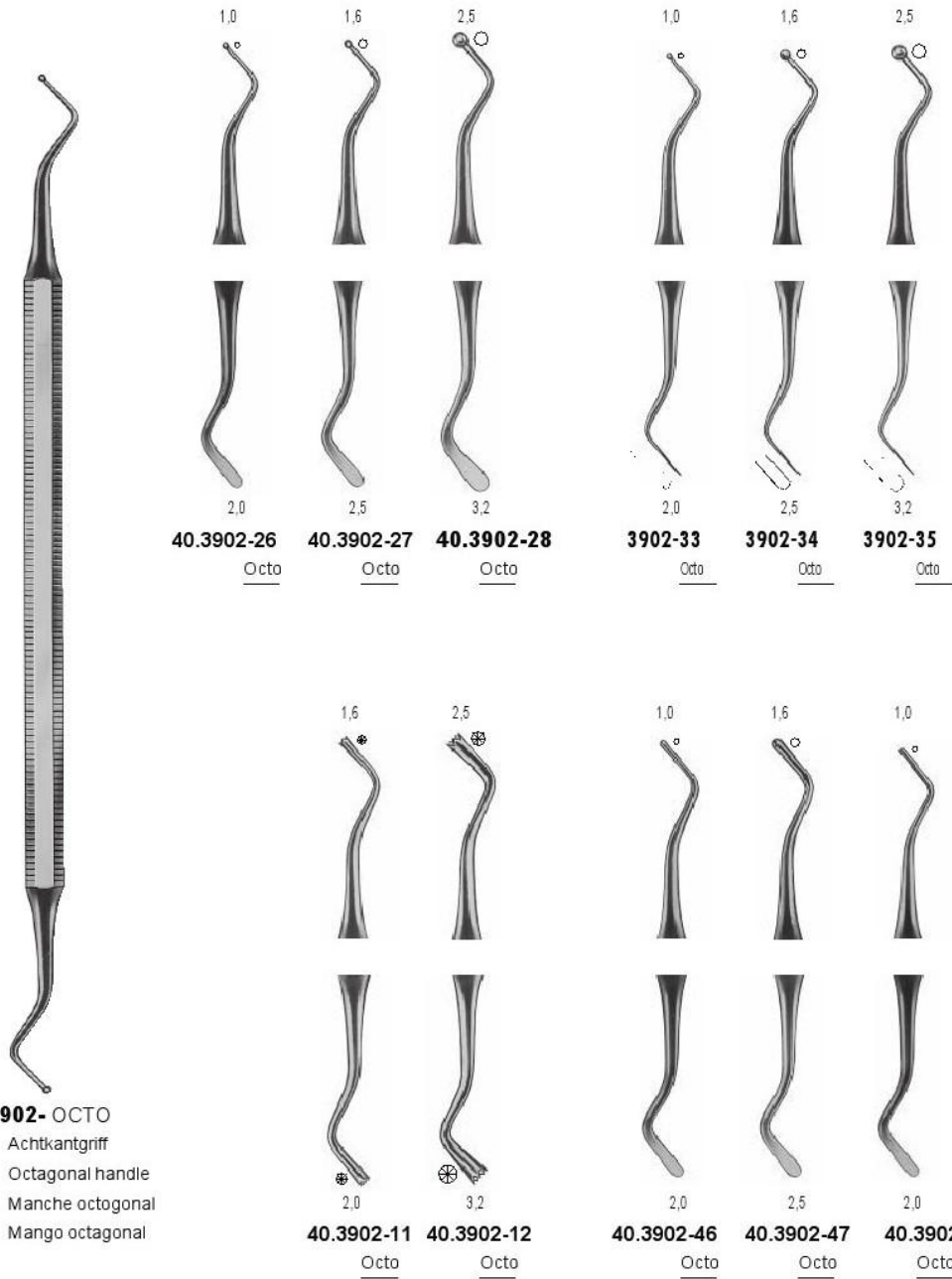

40

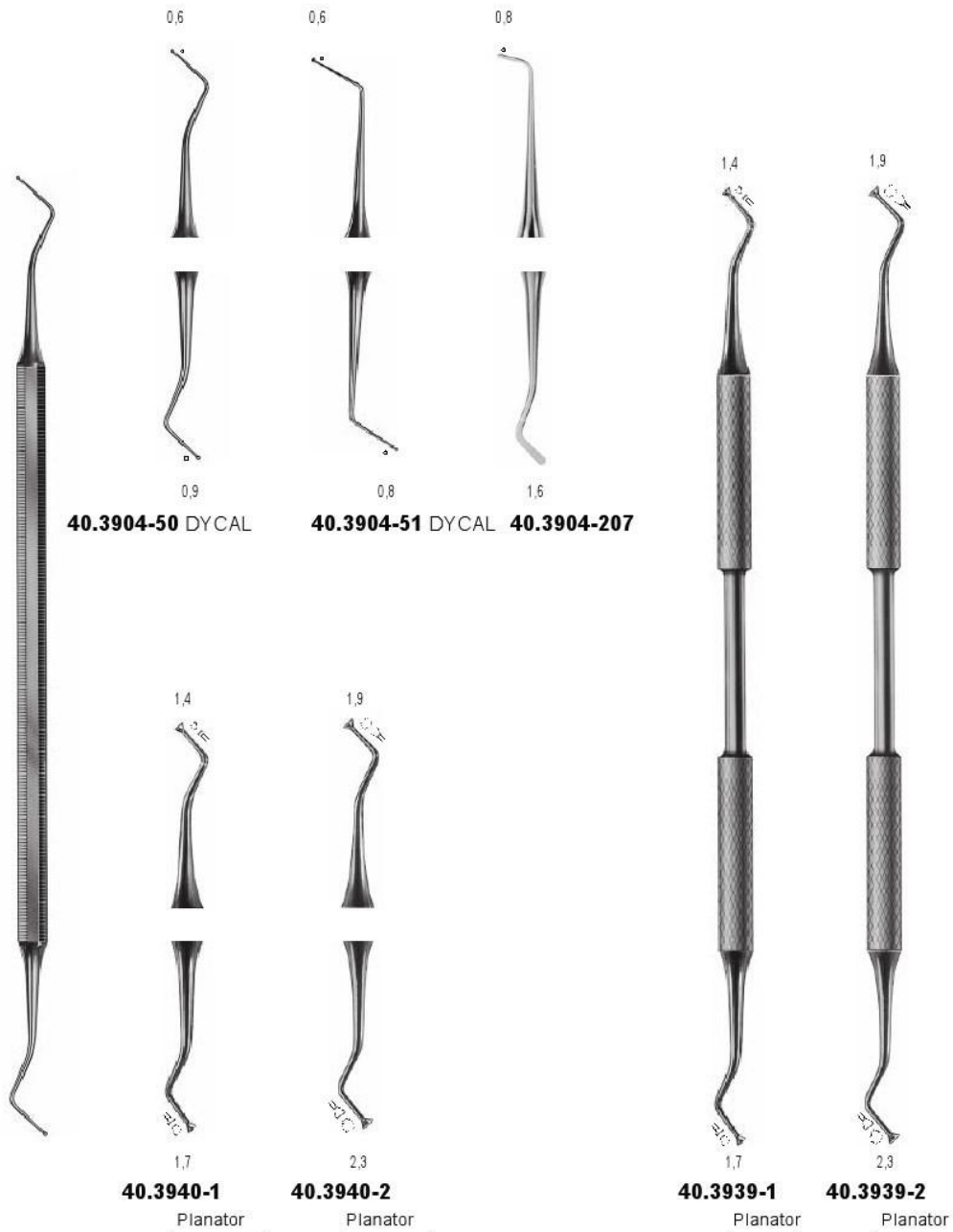

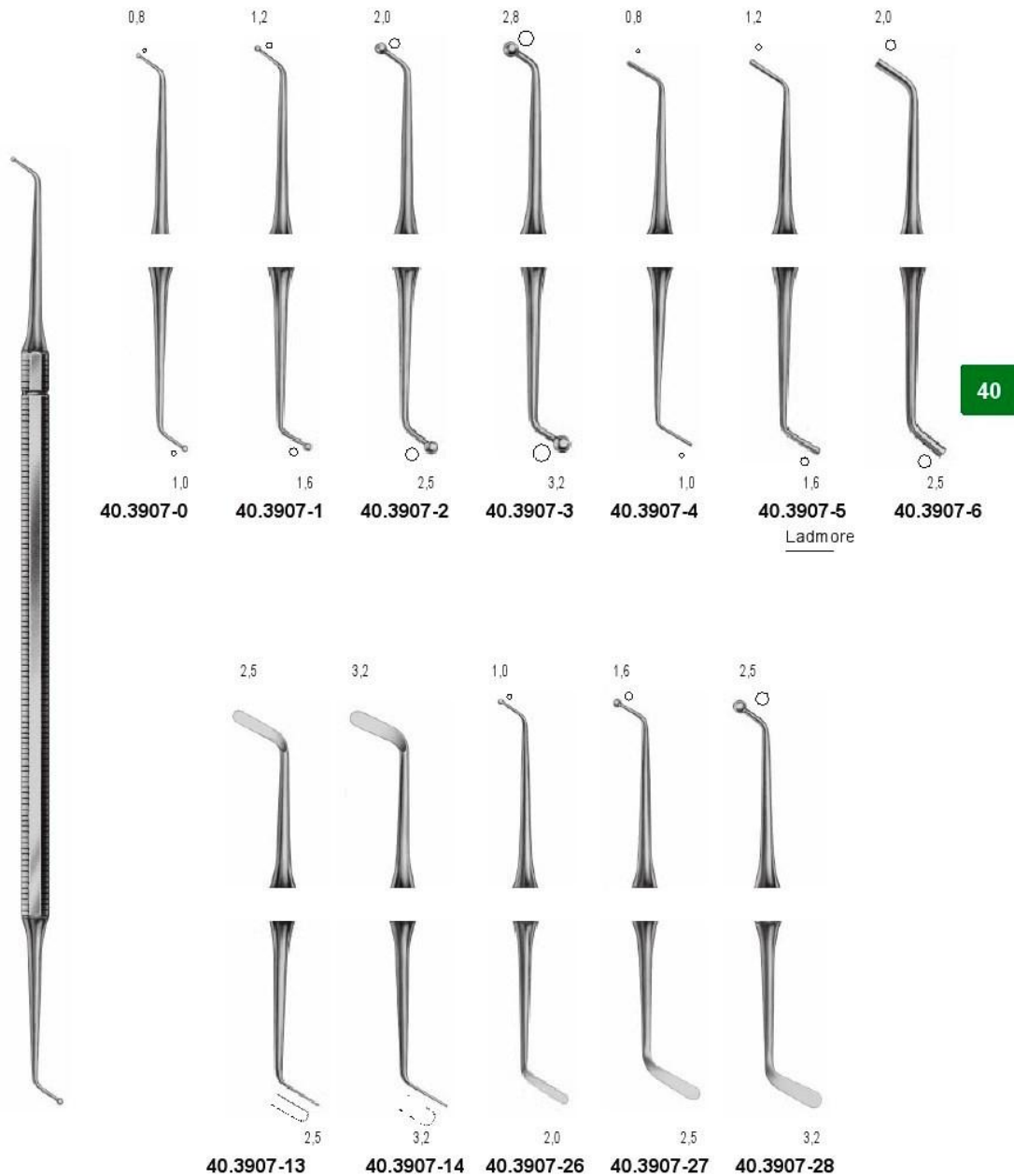

40

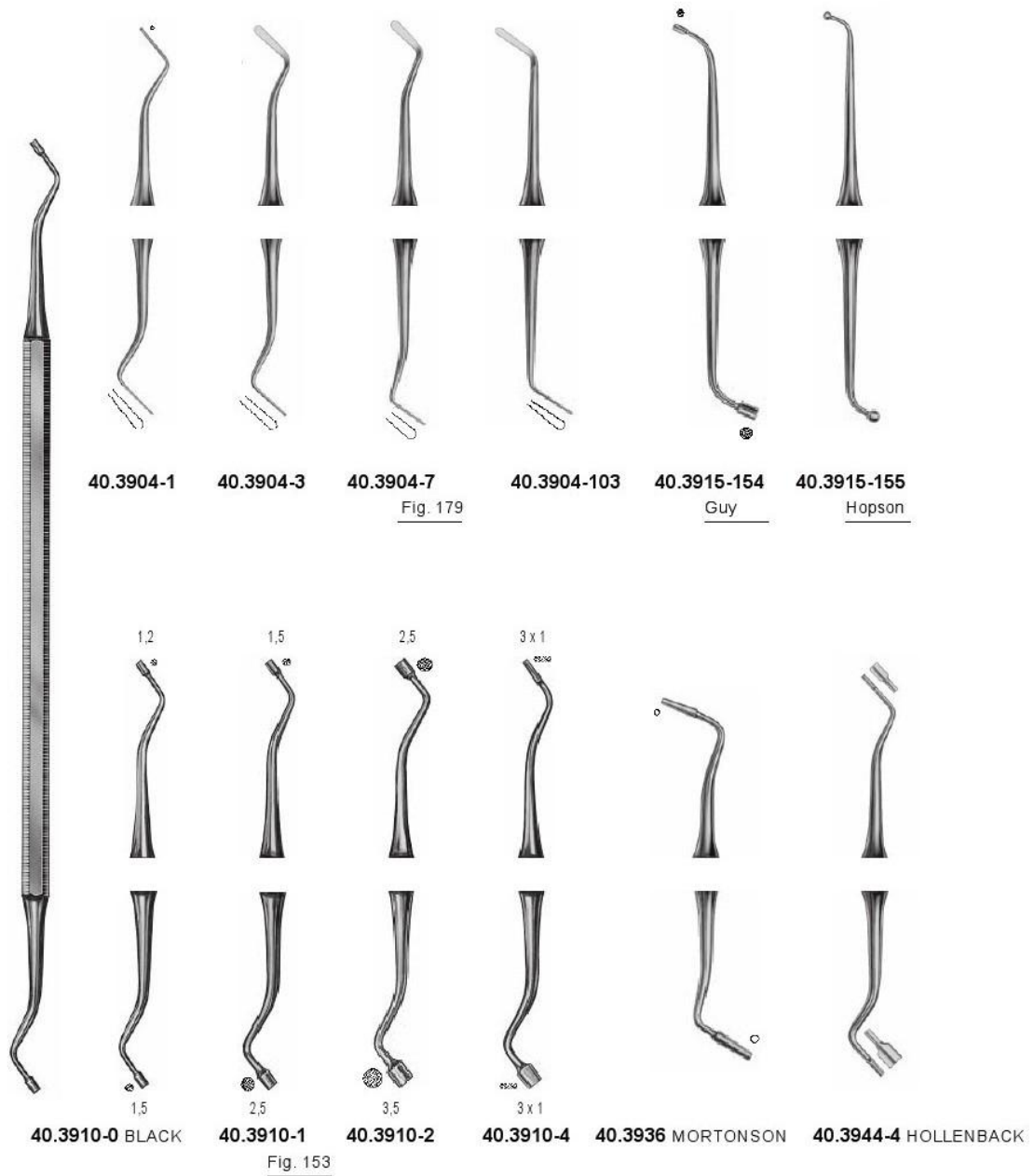

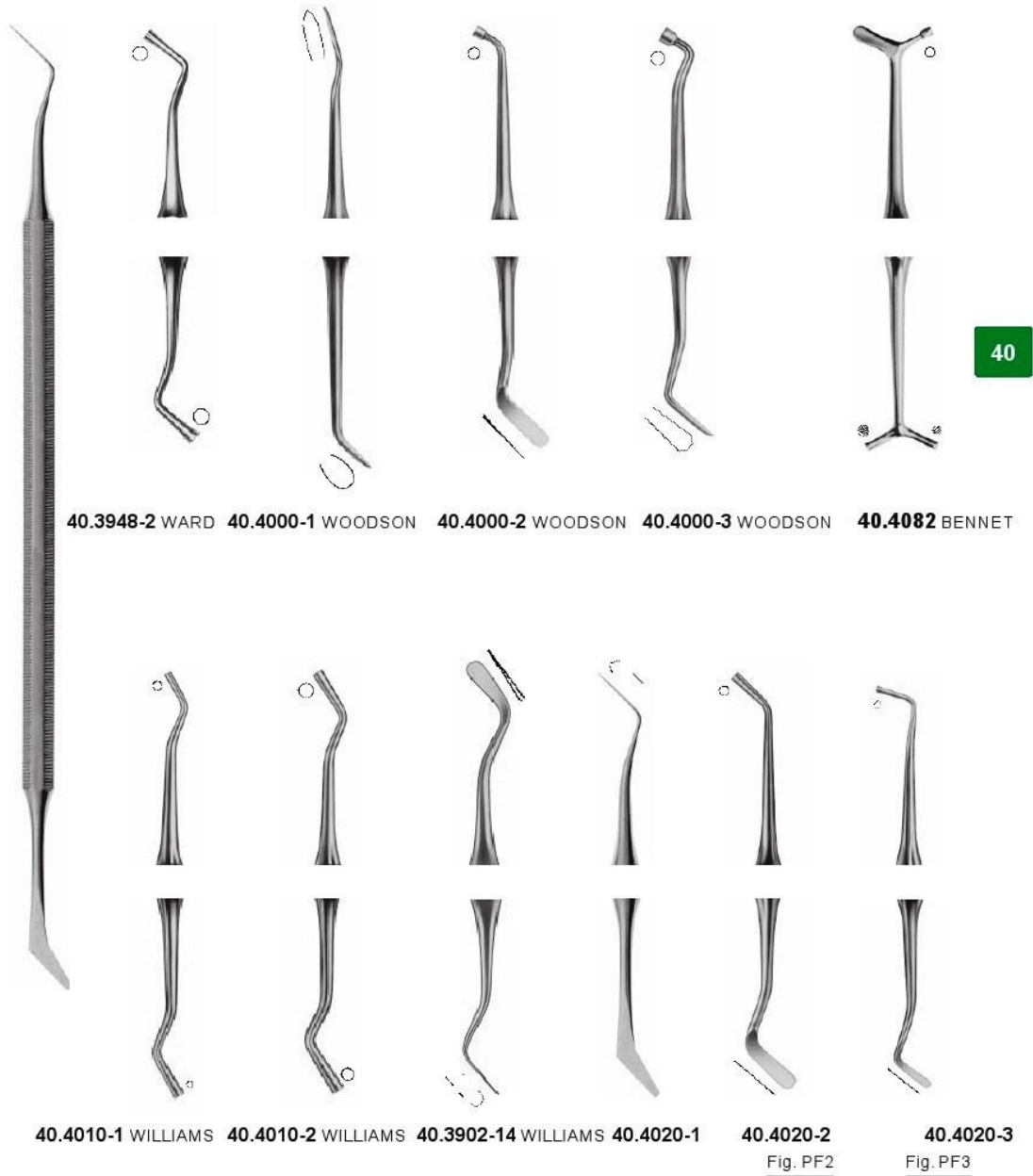

Starre Spatel
Rigid spatulas
Spatules rigides
Espátulas rígidas

40

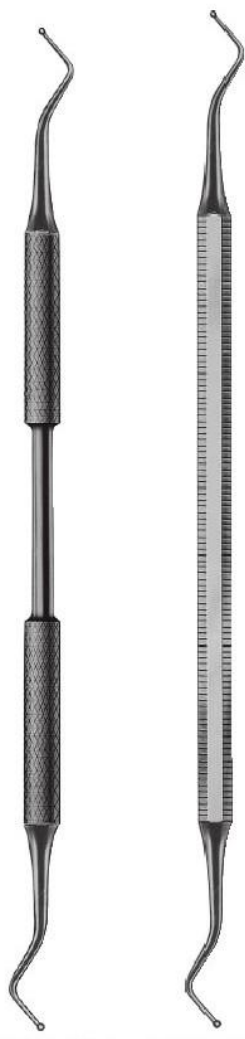

40.3901-ROTONDO
Rundgriff
Round handle
Manche rond
Mango redondo

40.3902-OCTO
Achtkantgriff
Octagonal handle
Manche octogonal
Mango octogonal



40.3902-15 **40.3902-16**
Octo Octo
40.3901-15 **40.3901-16**
Rotondo Rotondo

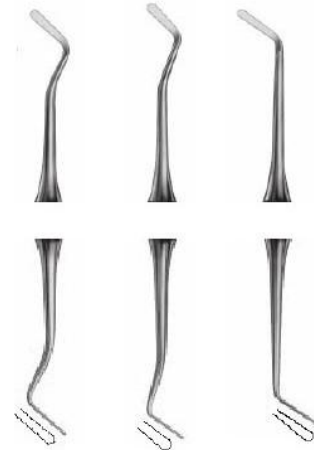

40.3904-3 **40.3904-7** FIG.179 **40.3904-103**
Octo Octo Octo

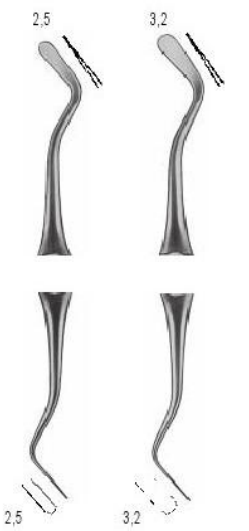

40.3902-13 **40.3902-14**
Octo Octo
40.3901-13 **40.3901-14**
Rotondo Rotondo



40.3907-13 **40.3907-14** **40.4050-4** FIG.156
Octo Octo Octo

Flexible Spatel
Flexible spatulas
Spatules flexibles
Espátulas flexibles

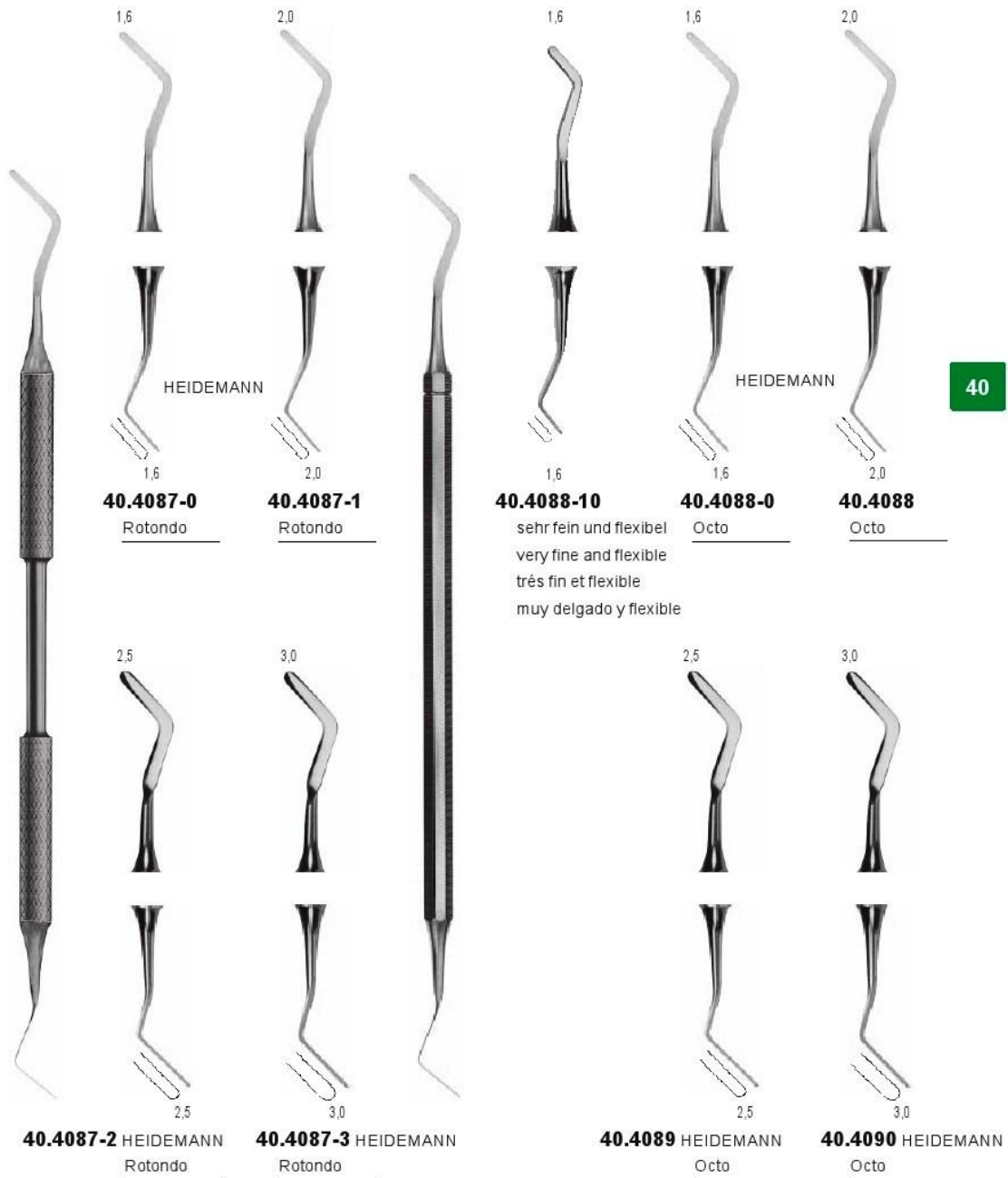

Composite Instrumente
 Composite instruments
 Instruments pour composite
 Instrumentos para composite

40

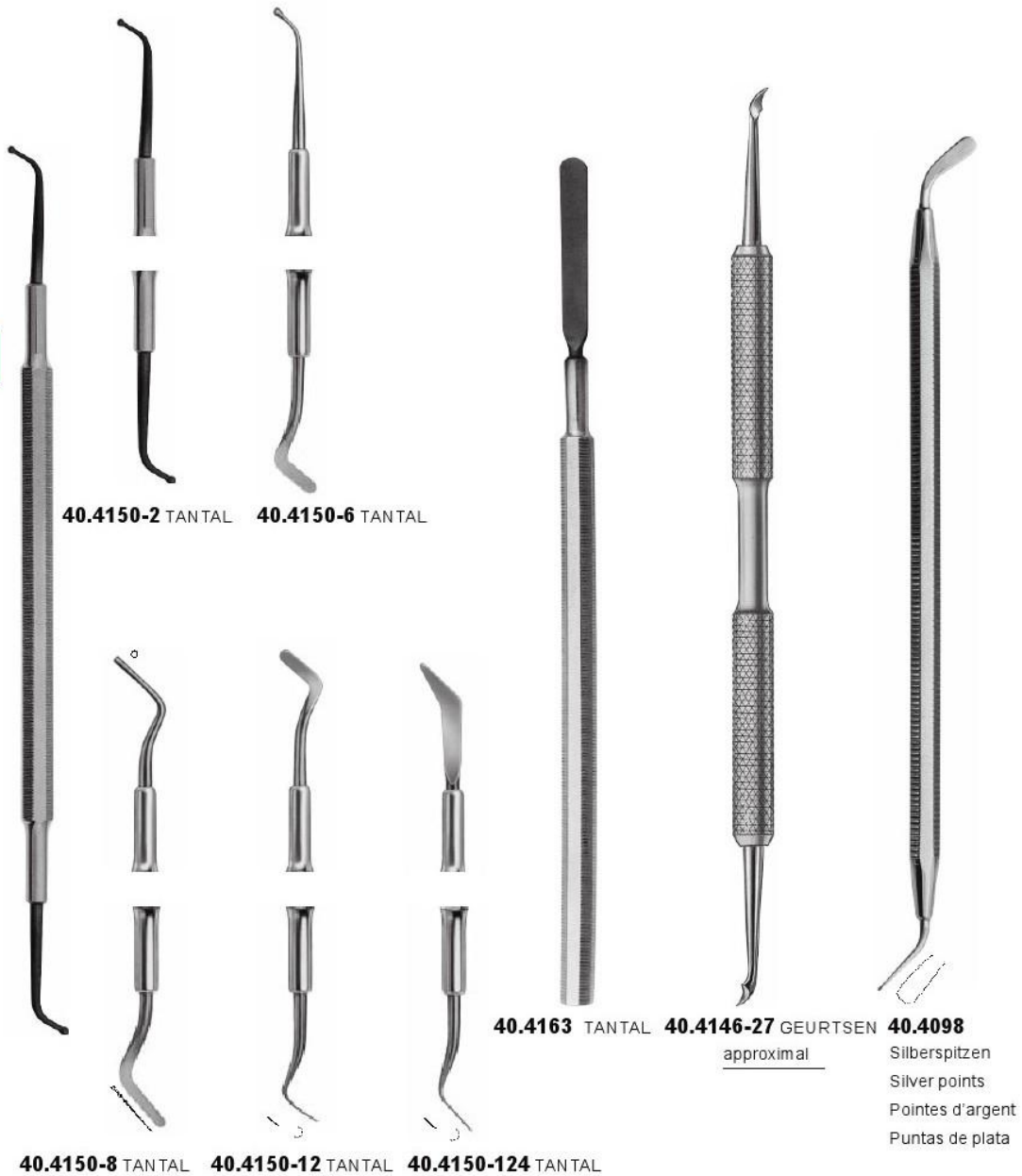

**Flexible Spatel
Flexible spatulas
Spatules flexibles
Espátulas flexibles**

- ▶ Hochglanzpolierte Arbeitsenden mit TiN-Beschichtung
- ▶ Reduziert Kleben des Composites am Instrument
- ▶ Kein Verfärben der Füllungen

- ▶ Working ends with high mirror polish and TiN-coating
- ▶ Reduces sticking of composite on instrument
- ▶ No discoloration of the composite materials

- ▶ Pointes avec polissage très fin et enduit TiN
- ▶ Réduit l'adhésion du composite sur l'instrument
- ▶ Aucune décoloration des matières composites

- ▶ Puntas con pulimento muy fino y capa TiN
- ▶ Reduzo la adherencia del composite sobre el instrumento
- ▶ Ninguna descoloración de los **materiales composite**



40

40.4086-10 40.4086-0 40.4086-1 40.4086-2 40.4086-3

sehr fein und flexibel
very fine and flexible
très fin et flexible
muy delgado y flexible

Starre Spatel
Rigid spatulas
Spatules rigides
Espátulas rígido

Füllungsinstrumente
Filling instruments
Instruments pour obturations
Instrumentos para obturaciones

Modellierinstrumente
Carving instruments
Instruments à modeler
Instrumentos para modelar

40

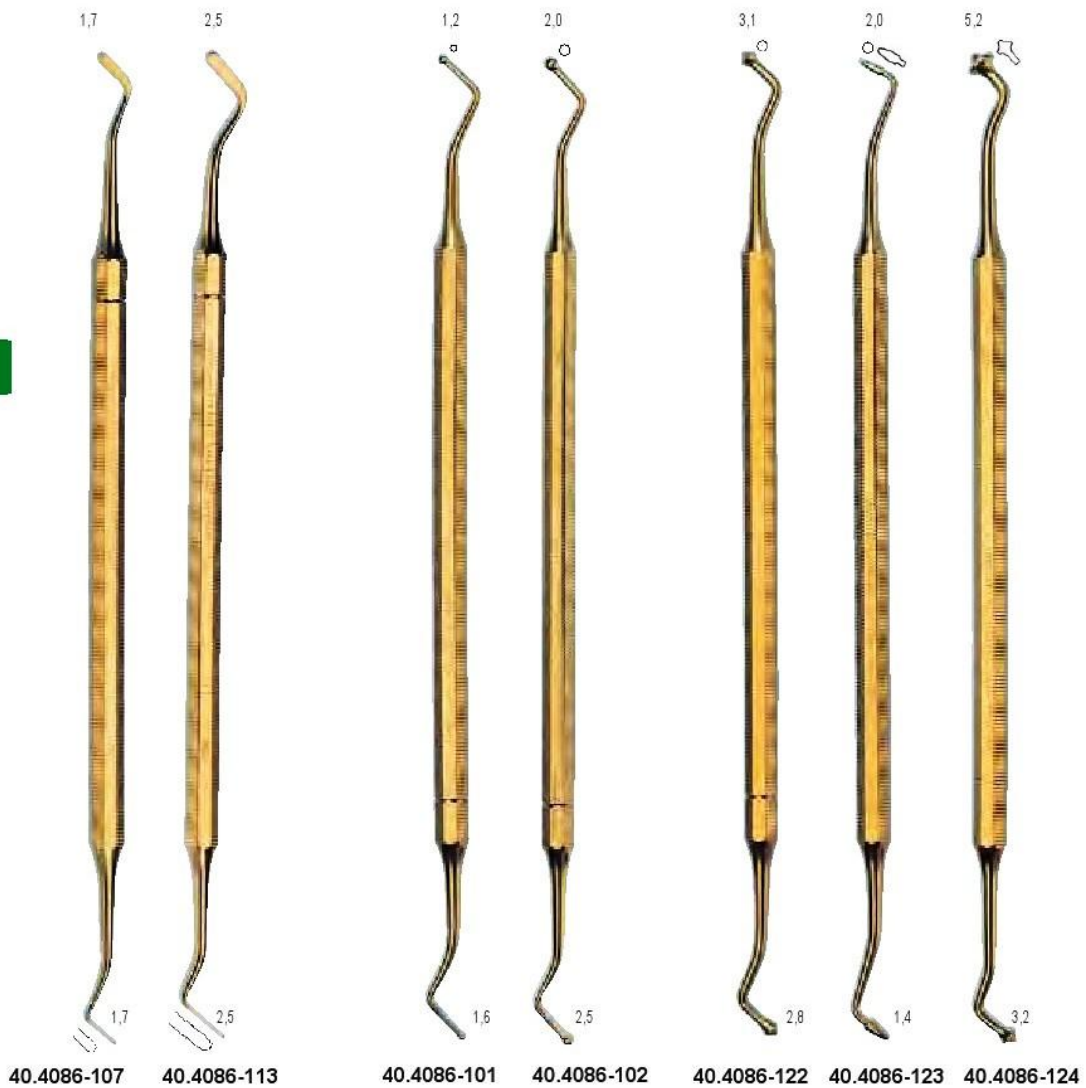

Modellierinstrumente
 Carving instruments
 Instruments à modeler
 Instrumentos para modelar

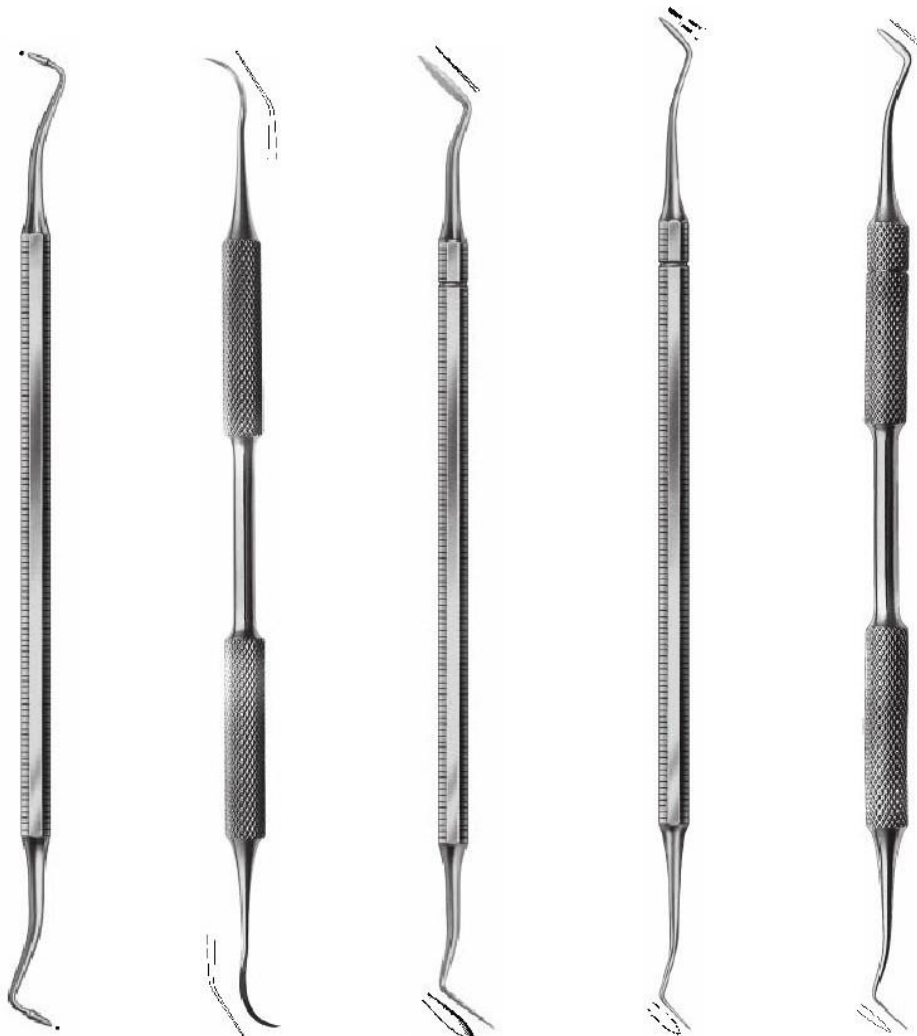

40

40.4123-3

40.4136 WILAND
 occlusal+
 approximal

40.4430 HOLLENBACK
 Fig. 3

40.4430-15 HOLLENBACK
 Fig. 3 S

40.4429-15 HOLLENBACK
 Fig. 3 S

Modellierinstrumente
Carving instruments
Instruments à modeler
Instrumentos para modelar

40



40.4432-1 WARD



40.4432-2 WARD



40.4426-1 NYSTRÖM



40.4426-2 NYSTRÖM



40.4426-3 NYSTRÖM

Modellierinstrumente
Carving instruments
Instruments à modeler
Instrumentos para modelar



Modellierinstrumente
Carving instruments
Instruments à modeler
Instrumentos para modelar

40

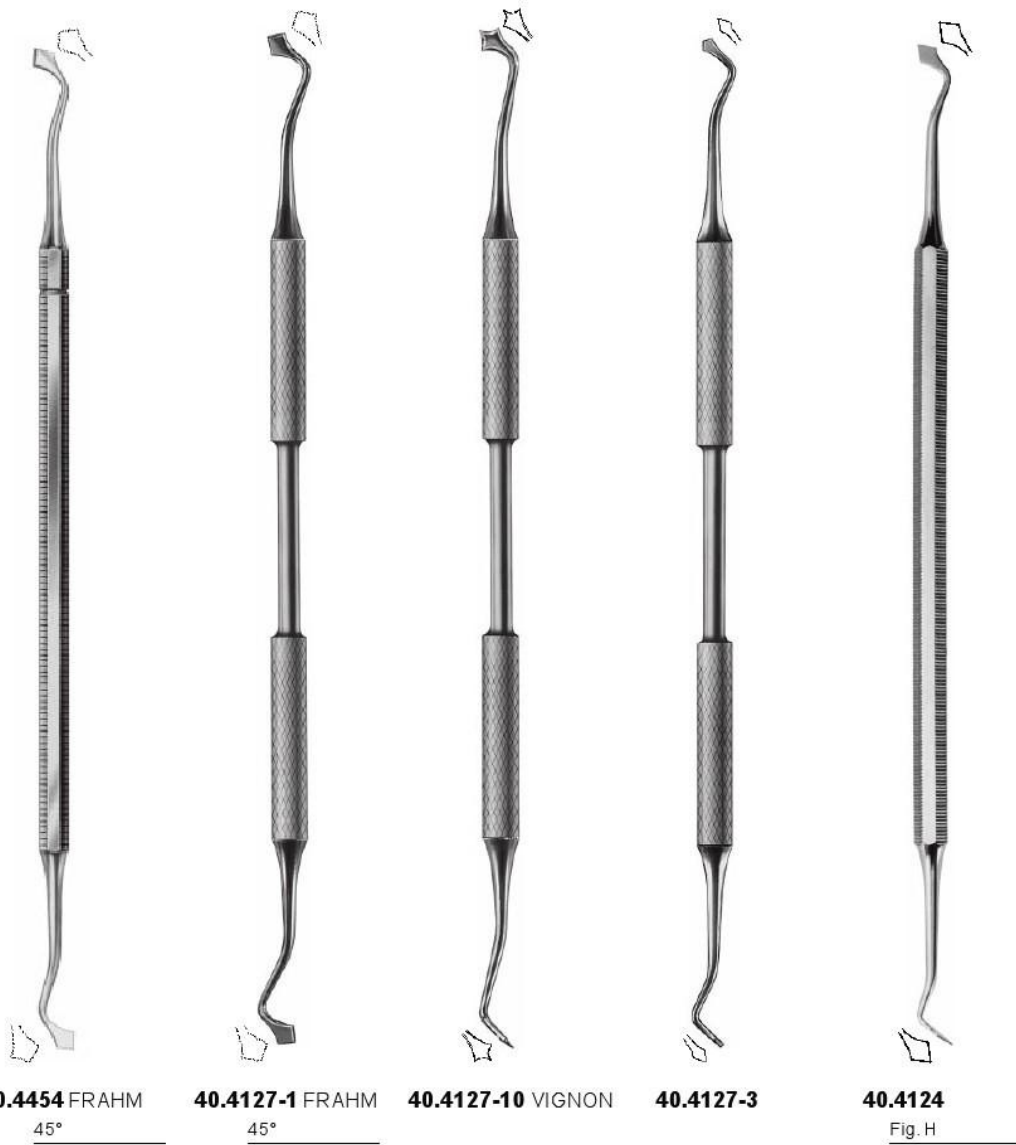

Polier
Burnishers
Brunissoires
Bruñidores



40.4121 WESTCOTT
Fig. 21



40.4122 WESTCOTT
Fig. 21B



40.4123
Fig. J



40.4126-1 WESTCOTT

40

Polierer
Burnishers
Brunissoires
Bruñidores

40



40.4126-10



40.4126-20 ROMEROWSKI



40.4133-2729

Fig. 27/29



40.4133-28D

Fig. 28/29

Zementspatel
Cement spatulas
Spatules à ciment
Espátulas para cemento



40.4325

flexibel
flexible
flexible
flexible



40.4327



40.4333

Achat
Agate
Agate
Agata



40.4310

40

40



40.4340

Fig. 8



40.4342-1



40.4342-2



40.4342-3

Kofferdam
 Rubber dam
 Digue de caoutchouc
 Dique de goma

40.3562

Kofferdam-Halter
 Rubber dam holder
 Porte-digues
 Sostenedor

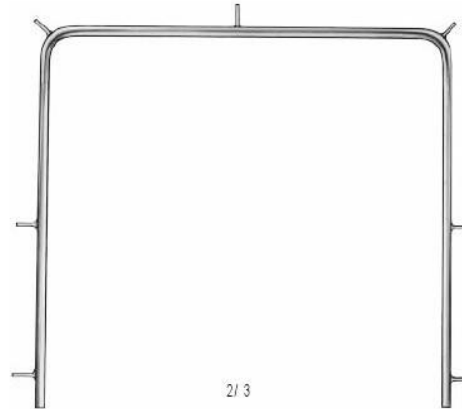

2/3

40



2/3

40.3550 AINSWORTH

17 cm, Lochzangen
 17 cm, punch forceps
 17 cm, pinces à perforer
 17 cm, perforadores



2/3

40.3552 IVORY

16 cm, Lochzangen
 16 cm, punch forceps
 16 cm, pinces à perforer
 16 cm, perforadores

Kofferdam
Rubber dam
Digue de caoutchouc
Dique de goma

40



40.3554
18 cm, Klammerzangen
18 cm, clamp forceps
18 cm, pincés porte-crampons
18 cm, portaclamps



40.3555 STOKES
17 cm, Klammerzangen
17 cm, clamp forceps
17 cm, pincés porte-crampons
17 cm, portaclamps



40.3557 BREWER
18 cm, Klammerzangen
18 cm, clamp forceps
18 cm, pincés porte-crampons
18 cm, portaclamps

Wurzelkanalinstrumente
 Root canal instruments
 Instruments radiculaires
 Instrumentos radiculares



40.3078
 Wurzelkanal-Sonde
 Explorer for root canal
 Sonde pour le canal
 Sonda para el canal



40.3463-49
 Ø 1,3 mm, Exkavator
 Ø 1,3 mm, Excavator
 Ø 1,3 mm, Excavateur
 Ø 1,3 mm, Excavadore



40.3463-50
 Ø 1,0 mm, Exkavator
 Ø 1,0 mm, Excavator
 Ø 1,0 mm, Excavateur
 Ø 1,0 mm, Excavadore



40.4937 IVORY
 Stiftzieher
 Post puller
 Instrument pour enlever les pivots
 Removedor de los pivotes

40

Wurzelkanal-Spreizer
Root canal spreaders
Fouloirs latéraux
Condensadores laterales

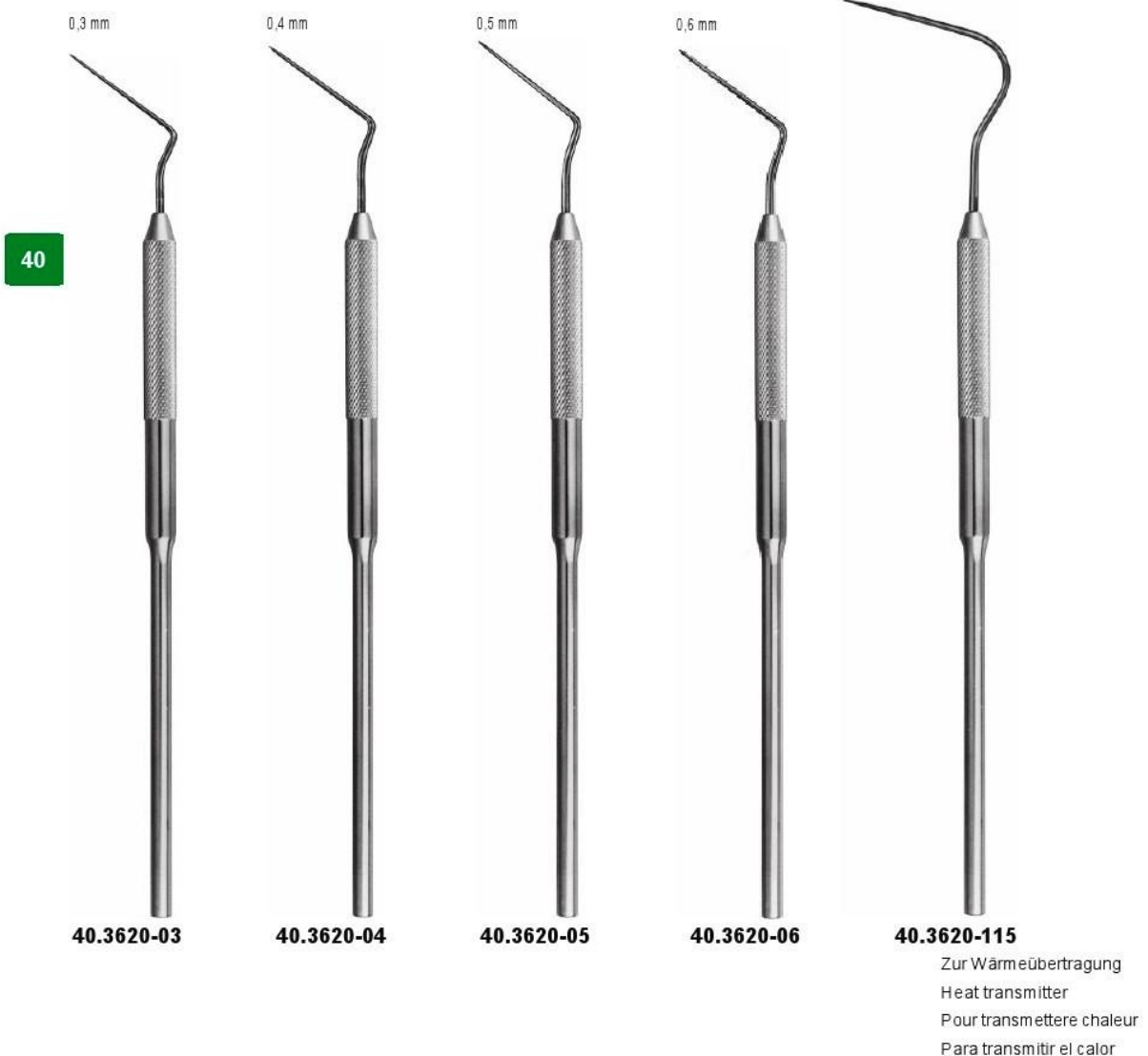

Wurzelkanal-Stopfer
 Root canal pluggers
 Fouloirs à canaux
 Obturadores radiculares

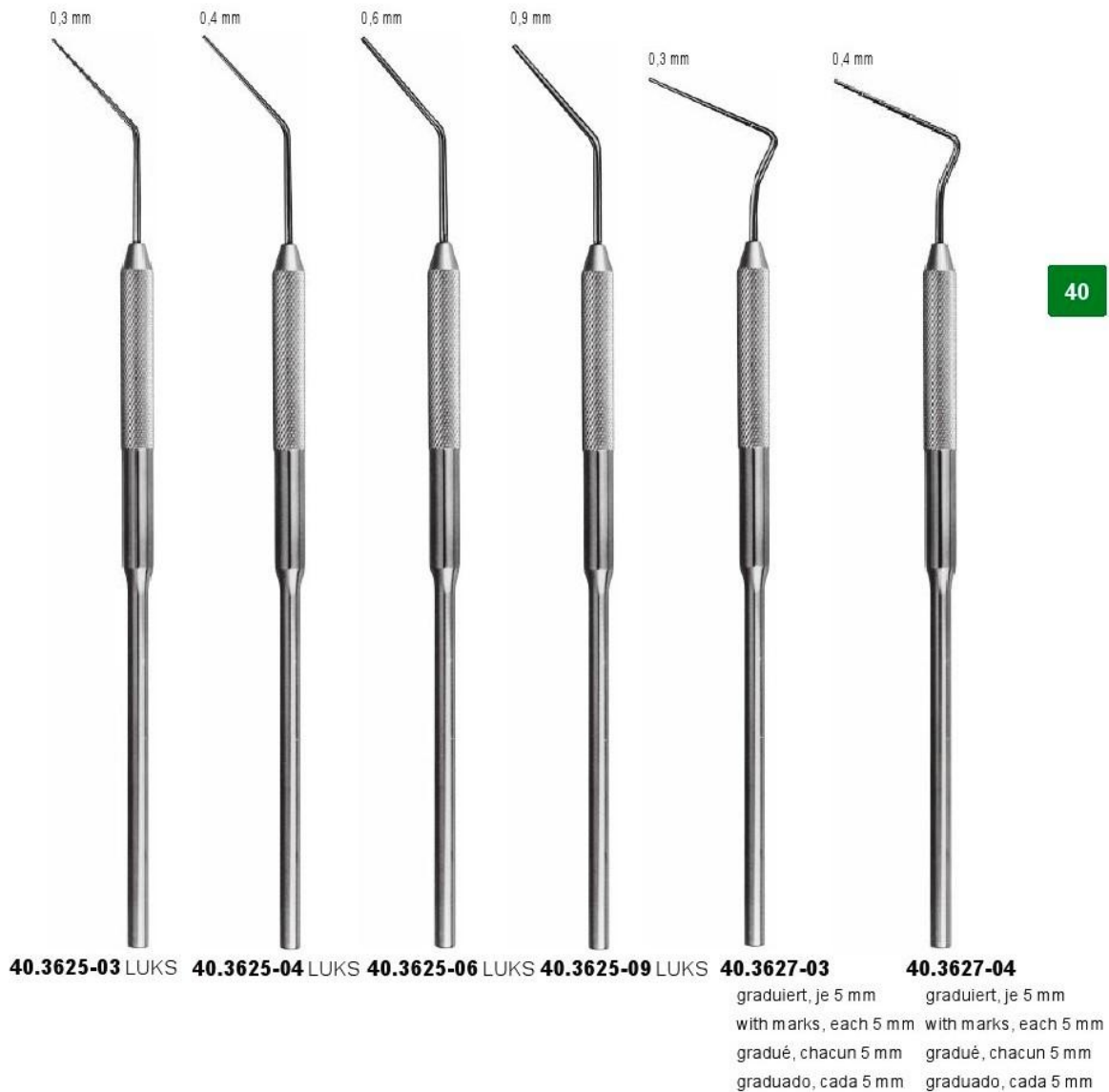

40

Wurzelkanal-Stopter
Root canal pluggers
Fouloirs à canaux
Obturadores radiculares

40

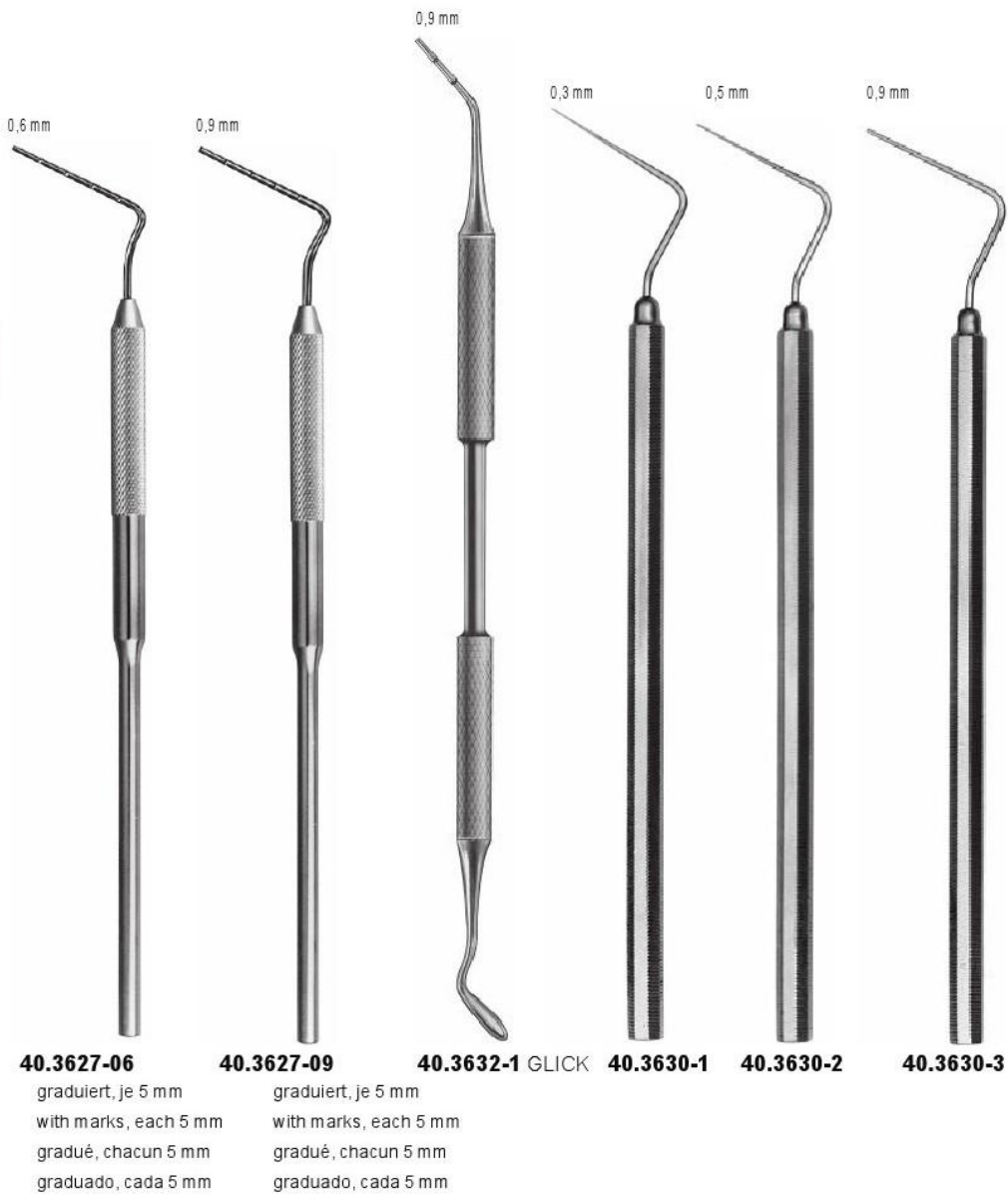



40.2908

Pinzetten für Silberspitzen
Silver points forceps
Pincés pour cônes d'argent
Pinzas para puntas de plata



40.2988

mit Schloß
with ratchet
avec arrêt
con cremallera



40.3661

für Wurzelstifte
for root pins
pour cônes radiculaires
para punta radicales



41

PROTHODONTIA /
ORTHODONTIA

PROTHETIK /
ORTHODONTIE

PROTHÉSE /
ORTHODONTIE

PROTODONCIA /
ORTODONCIA

Modellierinstrumente
Carving instruments
Instruments à modeler
Instrumentos para modelar

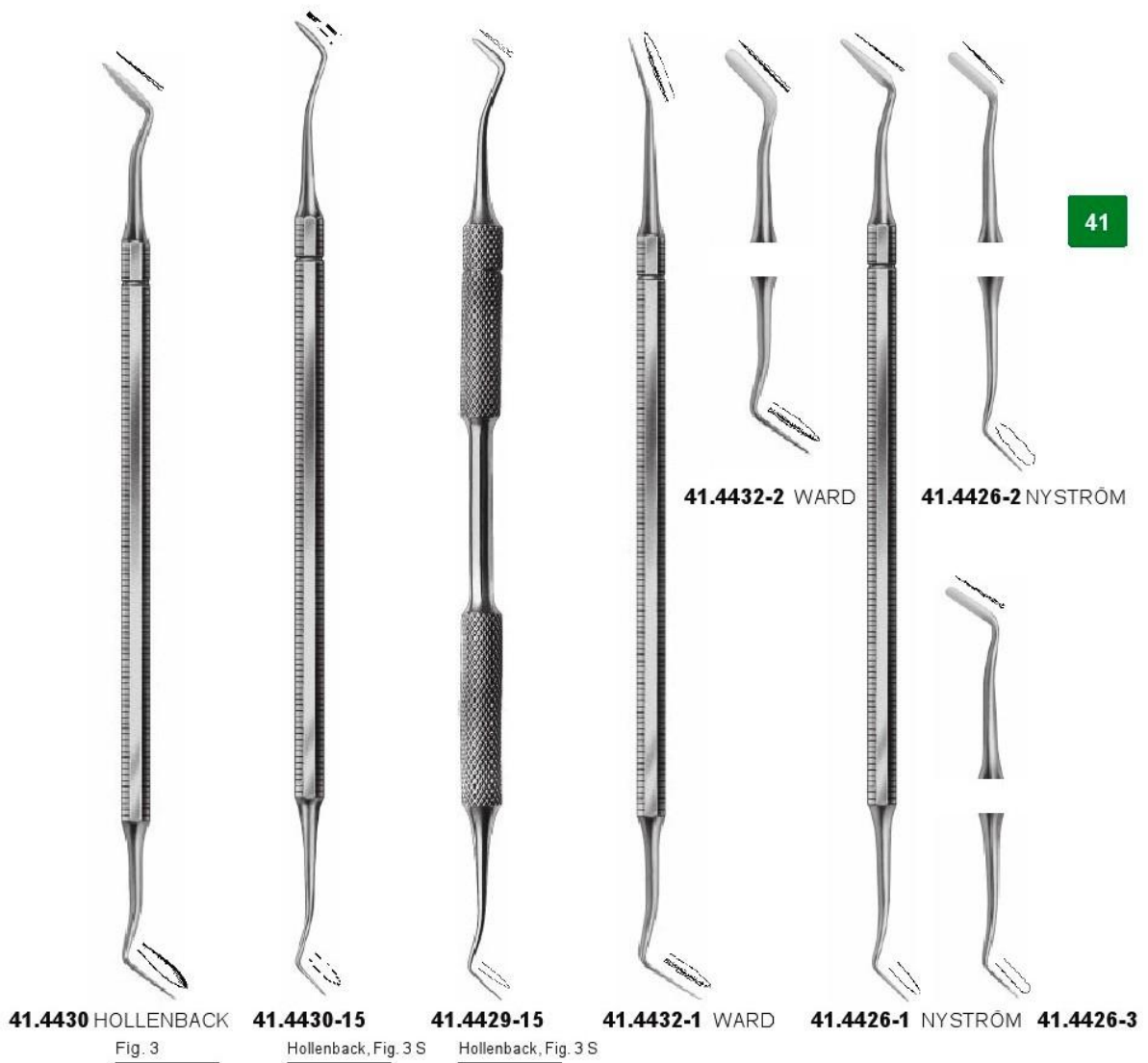

Modellierinstrumente
Carving instruments
Instruments à modeler
Instrumentos para modelar

41



41.4422 HYLIN

41.4421 ZAHLE

41.4441 ZAHLE

41.4444

41.4446 HYLIN-LE CRON

41.4447

41.4449

Modellierinstrumente
Carving instruments
Instruments à modeler
Instrumentos para modelar

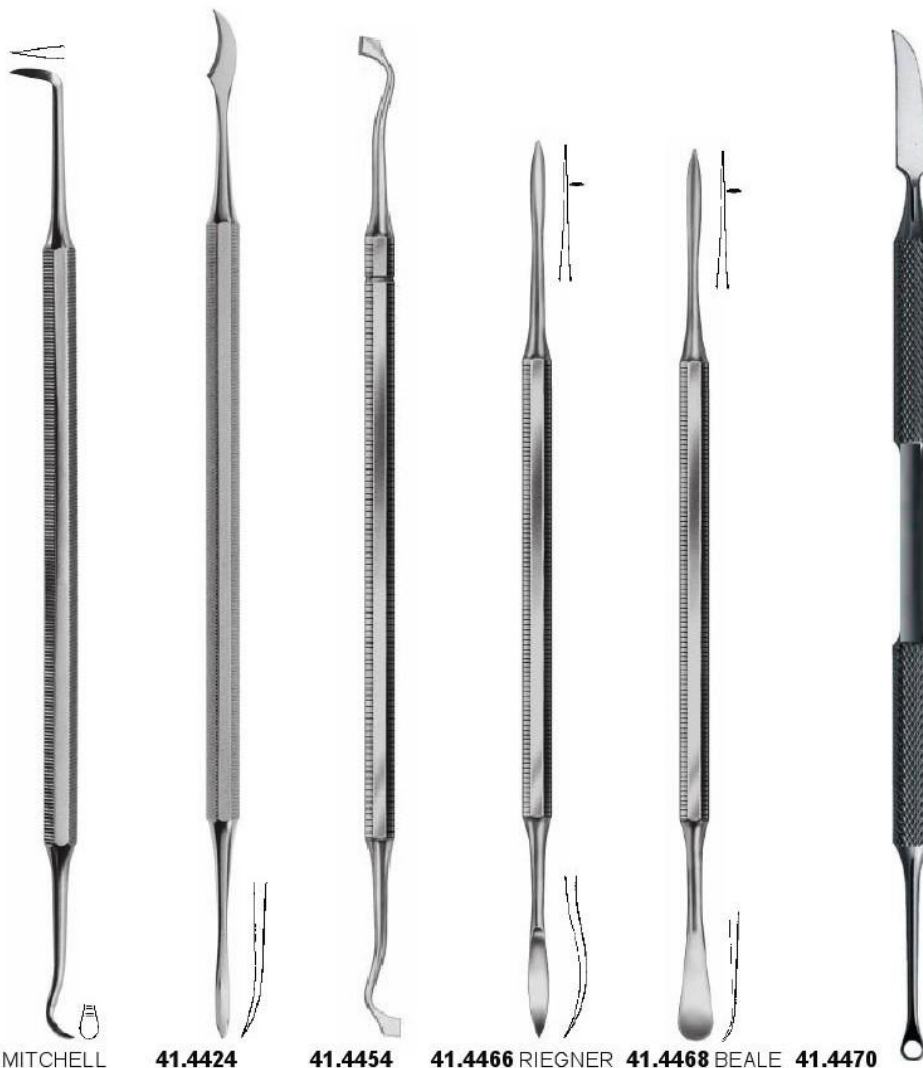

41.3254 MITCHELL

41.4424

41.4454
FRAHM

41.4466 RIEGNER

41.4468 BEALE

41.4470

Silikonmesser mit schneidender Öse
Silicone knife with cutting ring
Couteau à silicone
Cuchillo del silicón

Für Aufwachstechnik
For waxing-on technique
Pour la technique de moulage à cire
Para modelar en la técnica cerera

41



41.4480-1 P.K. THOMAS
Fig. 1



41.4480-2 P.K. THOMAS
Fig. 2



41.4480-3 P.K. THOMAS
Fig. 3



41.4480-4 P.K. THOMAS
Fig. 4



41.4480-5 P.K. THOMAS
Fig. 5



41.2913 PERRY

41.2631

120 ccm , Spirituslampe
 120 ccm , alcohol lamp
 120 ccm , lampe à alcool
 120 ccm , lámpara de alcc



2/3



2/3

41.6070

16 cm , Lötpinzette isoliert
 16 cm , soldering tweezers insulated
 16 cm , pince isolée
 16 cm , pinza aislada para soldar



1/2

41.6241

23 cm , Niethammer
 23 cm , riveting mallet
 23 cm , marteau à river
 23 cm , martillo para remachar



1/2

41.6245

22 cm , Hornhammer
 22 cm , horn mallet
 22 cm , maillet de corne
 22 cm , mazo de cuerno



41.4501 ERMERT

12 cm

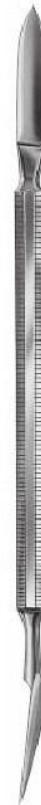

41.4502 ERMERT

14 cm

41

Wachsmesser
Wax knives
Couteaux à cire
Cuchillos para cera

41

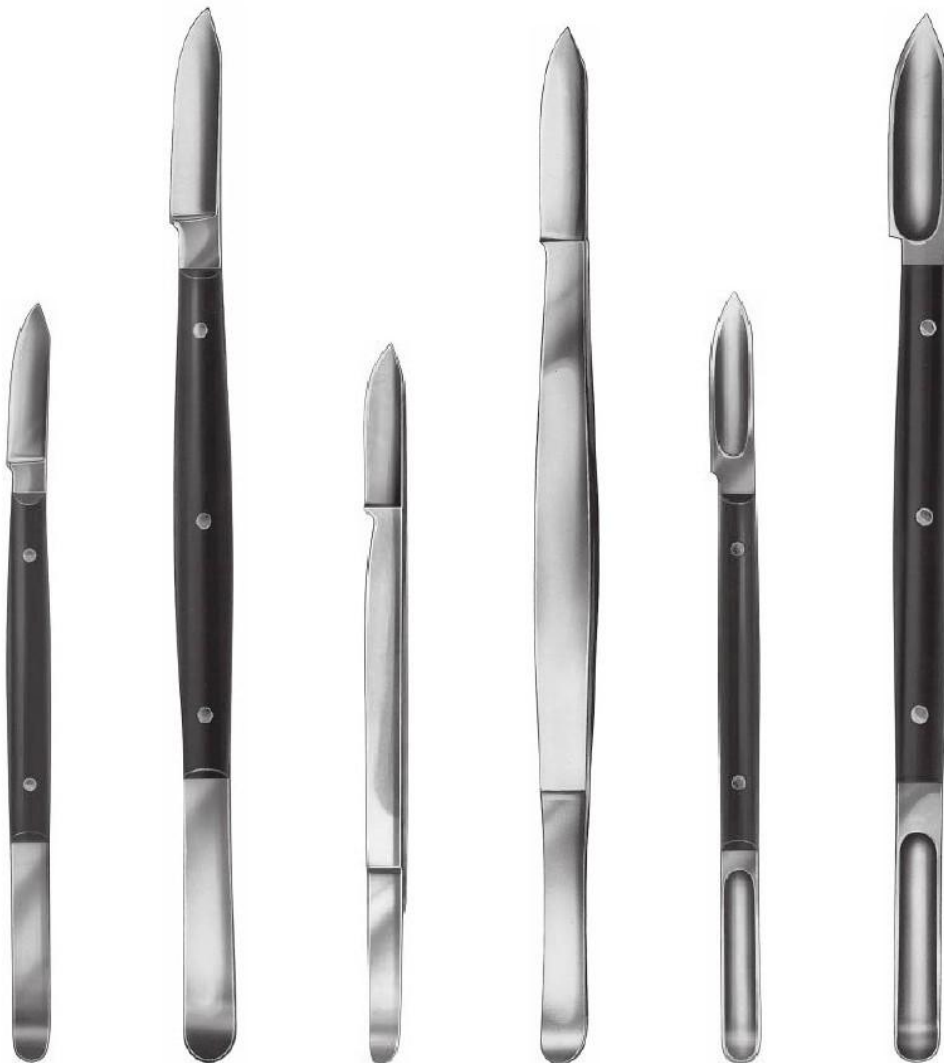

41.4510 FAHNEN-STOCK
13 cm

41.4512 FAHNEN-STOCK
17 cm

41.4516
12 cm

41.4517
17 cm

41.4520 LESSMANN
13 cm

41.4522 LESSMANN
17 cm

Gipsmesser
Plaster knives
Couteaux à plâtre
Cuchillos para yeso



41.4540
18 cm



41.4542 GRITMANN
16 cm



41.4545
18 cm



41.4546
15 cm



41.4558
20 cm, Gipsschneidezange
20 cm, plaster cutting pliers
20 cm, pince à couper plâtre
20 cm, alicate para cortar yeso

41

Spatel für Abdruckmasse
 Spatulas for impression materials
 Spatules pour matériaux d'empreintes
 Espátulas para materiales de impresión

41



41.4560

19 cm, sehr flexibel
 19 cm, very flexible
 19 cm, très flexible
 19 cm, muy flexible

41.4562

22 cm

41.4565

21 cm

41.4570 LICHTENSTEIN

17 cm

41.4571

20 cm

Kronen- und Blechscheren
Crown and plate scissors
Ciseaux à couronnes et tôle
Tijeras para coronas y planchas

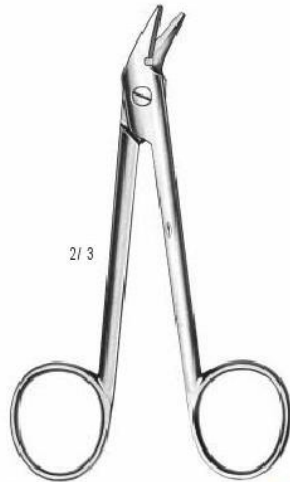

41.4862
 12 cm, gezahnt
 12 cm, saw edge
 12 cm, dentelés
 12 cm, dentadas



41.4863 TC GOLD
 12 cm, Hartmetalleinsätze
 12 cm, tungsten carbide insert
 12 cm, pointes en tungstène
 12 cm, puntas de tungsteno



41.4865
 10,5 cm, gebogen
 10,5 cm, curved
 10,5 cm, courbes
 10,5 cm, curvas

41



41.4821 BEEBEE
 10,5 cm, spitz, gerade
 10,5 cm, sharp, straight
 10,5 cm, pointus, droits
 10,5 cm, agudas, rectas



41.4825 BEEBEE
 spitz, gebogen
 sharp, curved
 pointus, courbes
 agudas, curvas



41.4841
 12 cm, gerade, gezahnt
 12 cm, straight, saw edge
 12 cm, droits, dentelés
 12 cm, rectas, dentadas



41.4845
 gebogen, gezahnt
 curved, saw edge
 courbes, dentelés
 curvas, dentadas

Kupferringabnehmezange
 Copper ring removing pliers
 Pince à enlever les bagues en cuivre
 Pinza para sacar anillos de cobre

Retraktionsfadenstopfer
 Gingival cord packer
 Pour fil retracteur
 Para hilo retractor

41



41.4946 FURRER
 15 cm



41.4880-1
 gezahnt
 saw edge
 dentelés
 dentadas



41.4880-2
 gezahnt
 saw edge
 dentelés
 dentadas



41.4880-3 UNIVERSAL
 45°, gezahnt
 45°, saw edge
 45°, dentelés
 45°, dentadas



41.4890 MILLER
 Artikulationspapierpinzette
 Forceps for articulating paper
 Pince pour papier à articuler
 Pinza para papel de articular



41.4937 IVORY
 Stiftzieher
 Post puller
 Instrument pour enlever les pivots
 Removedor de los pivotes

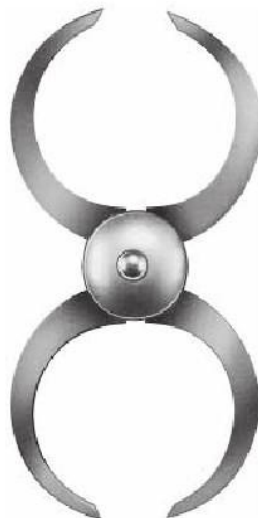

41.4892
 Tasterzirkel
 Caliper
 Compas d'épaisseur
 Calibre



41.4894-1 IWANSON
 10 cm, für Wachs
 10 cm, for wax
 10 cm, pour cire
 10 cm, para cerera

41.4894 IWANSON
 10 cm, Zehntelmaß
 10 cm, decimal caliper
 10 cm, calibre décimal
 10 cm, calibrador decimal

Kronenabnehmer
 Crown removers
 Instruments à détacher les couronnes
 Instrumentos para quitar coronas

41



41.4920 TREYMANN



41.4924-1 41.4924-2 41.4924-3

41.4924 MORELL

mit Ansätzen Nr. 41.4924-1 + 41.4924-2
 with tips No. 41.4924-1 + 41.4924-2
 avec pointes No. 41.4924-1 + 41.4924-2
 con puntas No. 41.4924-1 + 41.4924-2

41.4924-10 MORELL

komplett mit 3 Ansätzen
 complete with 3 tips
 complet avec 3 pointes
 completo con 3 puntas



41.4925 MORELL

mit Ansätzen Nr. 41.4924-1 + 41.4924-2
 with tips No. 41.4924-1 + 41.4924-2
 avec pointes No. 41.4924-1 + 41.4924-2
 con puntas No. 41.4924-1 + 41.4924-2

41.4925-10 MORELL

komplett mit 3 Ansätzen
 complete with 3 tips
 complet avec 3 pointes
 completo con 3 puntas

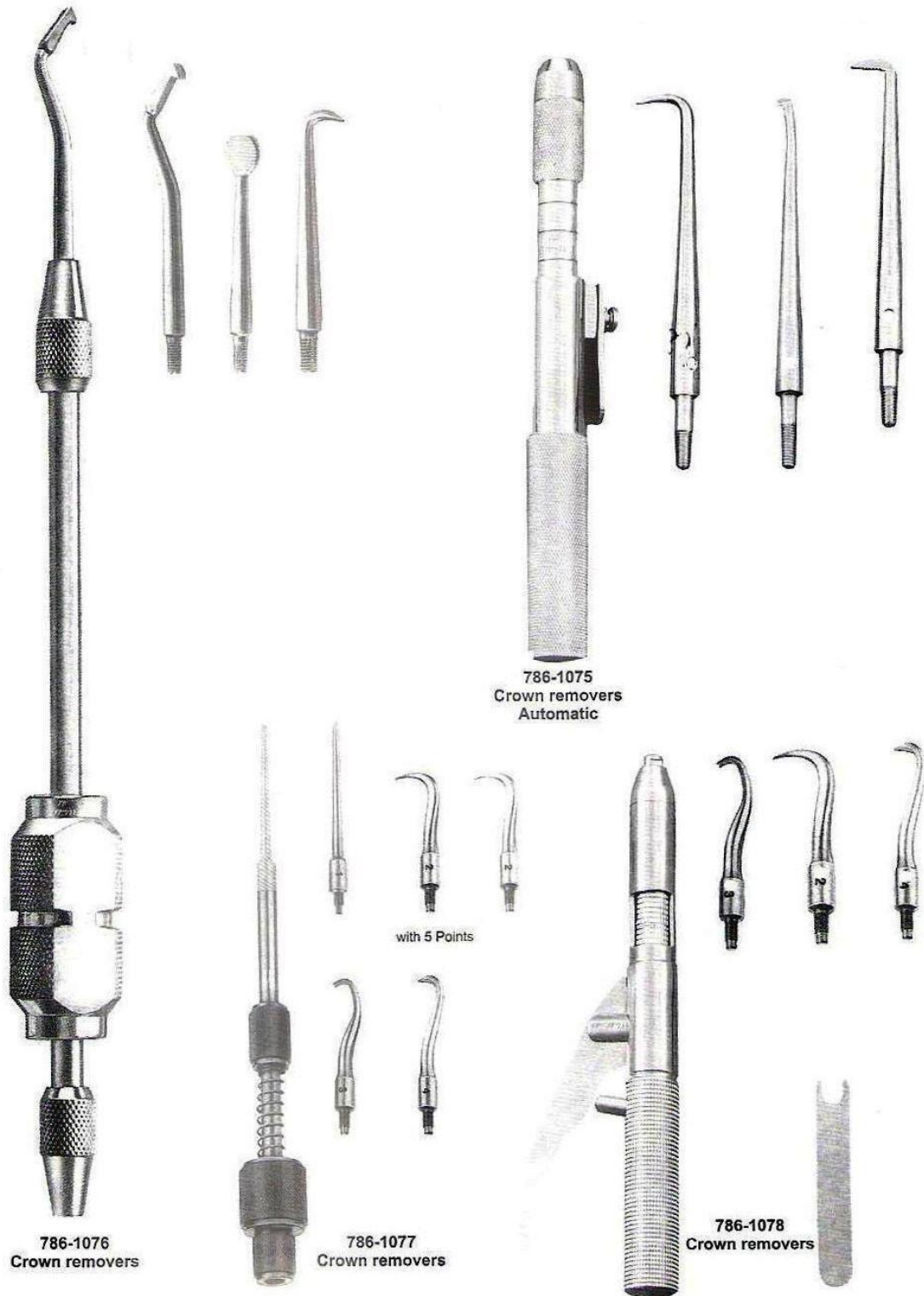

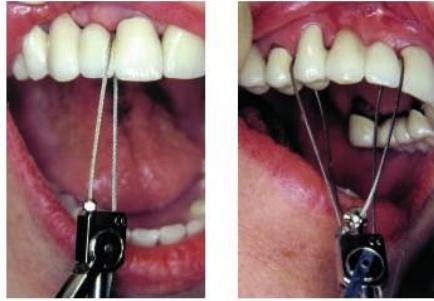

Kronenabnehmer Lift-ex
Crown removers Lift-ex
Instruments à détacher les couronnes Lift-ex
Instrumentos para quitar coronas Lift-ex



41.4924-21 SINGLE-LOOP TIP
 Set mit 1 Single-Loop Tip, Adapter und Schlüssel
 Set with 1 Single-Loop Tip, adapter and key
 Ensemble avec 1 Single-Loop Tip, adaptateur et clé
 Sistema con 1 Single-Loop Tip, adaptador y llave

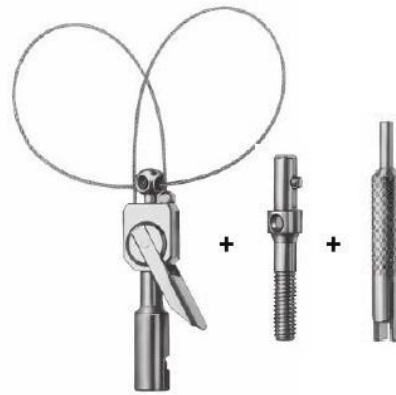

41.4924-22 DOUBLE-LOOP TIP
 Set mit 1 Single-Loop Tip, Adapter und Schlüssel
 Set with 1 Single-Loop Tip, adapter and key
 Ensemble avec 1 Single-Loop Tip, adaptateur et clé
 Sistema con 1 Single-Loop Tip, adaptador y llave

41



41.4924-26
 Adapter
 Adapter
 Adaptateur
 Adaptador



41.4924-25
 Schlüssel
 Key
 Clé
 Llave



41.4924-31
 Ersatzschleife f. Single-Loop Tip
 Spare loop for Single-Loop Tip
 Boucle disponible pour Single-Loop Tip
 Lazo de repuesto por Single-Loop Tip

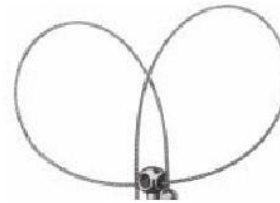

41.4924-32
 Ersatzschleife f. Double-Loop Tip
 Spare loop for Double-Loop Tip
 Boucle disponible pour Double-Loop Tip
 Lazo de repuesto por Double-Loop Tip

Kronenabnehmer
Crown removers
Instruments à détacher les couronnes
Instrumentos para quitar coronas



Kronenabnehmezangen
 Crown trial forceps
 Pinces pour couronnes en ceramique
 Alicates para coronas ceramicas

41.4940-100

- 1 Paar Kunststoffbacken
- 1 pair of inserts
- 1 paire de protecteurs
- 1 pareja de capas



41.4940-17
 13 - 18, 23 - 28



41.4940-22
 33 - 38, 43 - 48



41.4940-217
 3 - 8
 Amerikanische Form
 American pattern
 Modèle américain
 Modelo americano

41

Teleskopkronenzangen
 Pliers for telescope crowns
 Pinces pour couronnes telescopes
 Alicates para coronas telescópicas

41



41.4947 BÖHM
15 cm



41.4947-2 BÖHM
13 cm, fein
13 cm, fine
13 cm, gracile
13 cm, grácil



41.4947-5
13,5 cm, diamantierte Spitzen
13,5 cm, diamond tips
13,5 cm, pointes diamantées
13,5 cm, puntas diamantadas

41.4947-6

- 1 Paar Ersatzspitzen
- 1 pair of replacement tips
- 1 paire de pointes de rechange
- 1 pareja de puntas de recambio



**Stainless Steel Impression Trays
Made of 18/8 Stainless Steel**

**Solid Partial Set of 10
786-001wa**



All the above impression trays are available in these 5 sizes

UPPER	UPPER					LOWER	LOWER				
	U1	U2	U3	U4	U5		L1	L2	L3	L4	L5
A	62	60	53	54	52	A	63	61	57	60	53
B	83	75	73	69	68	B	82	81	78	74	71

All Dimension are in mm

All Dimension are in mm

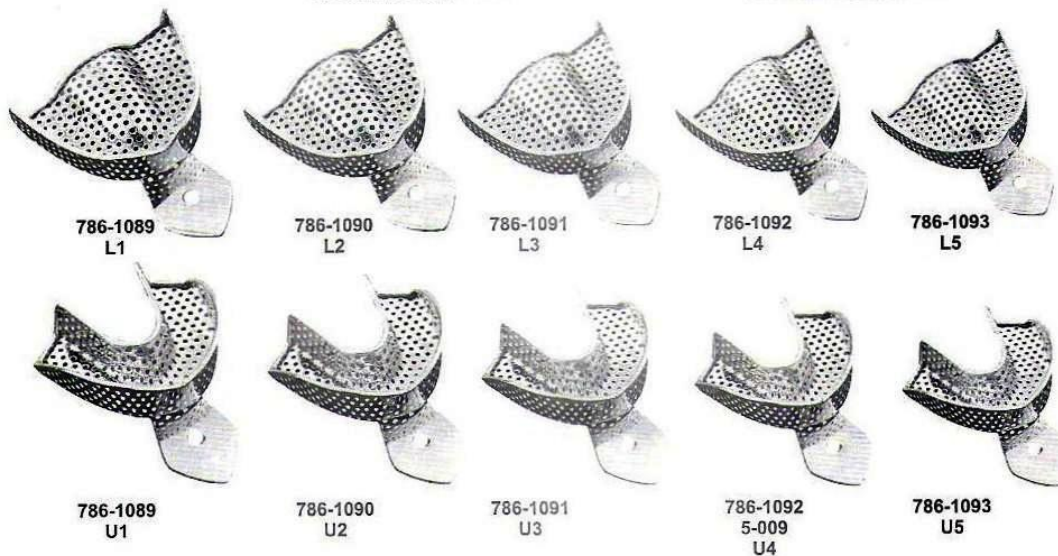

**Perforated Partial Set of 10
786-010wa**

Stainless Steel Impression Trays Made of 18/8 Stainless Steel

Solid Full Denture Set of 8 786-011wa

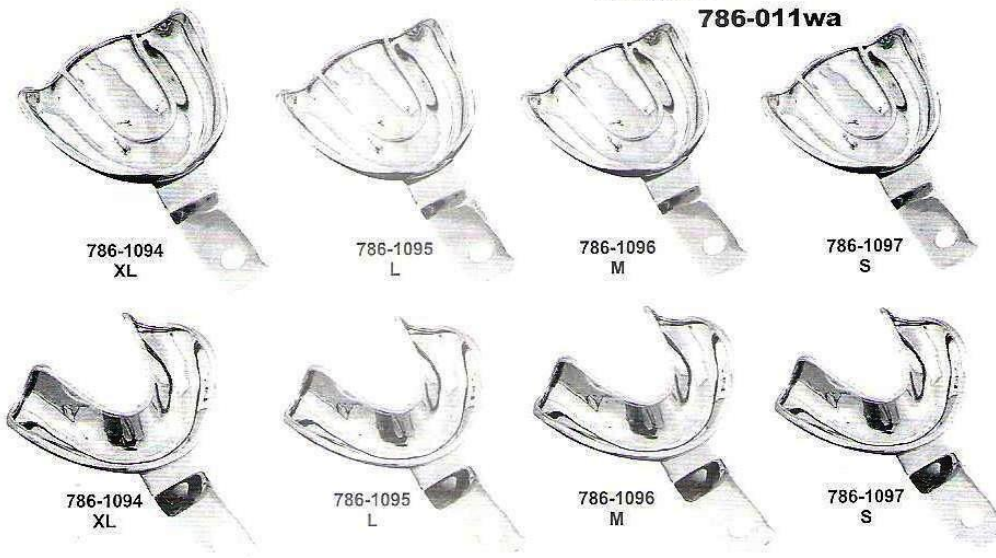

All the above impression trays are available in these 4 sizes

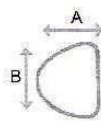

UPPER	XL	L	M	S
	A	70	67	64
B	79	76	70	73

All Dimension are in mm

LOWER	XL	L	M	S
	A	64	64	60
B	86	70	73	70

All Dimension are in mm

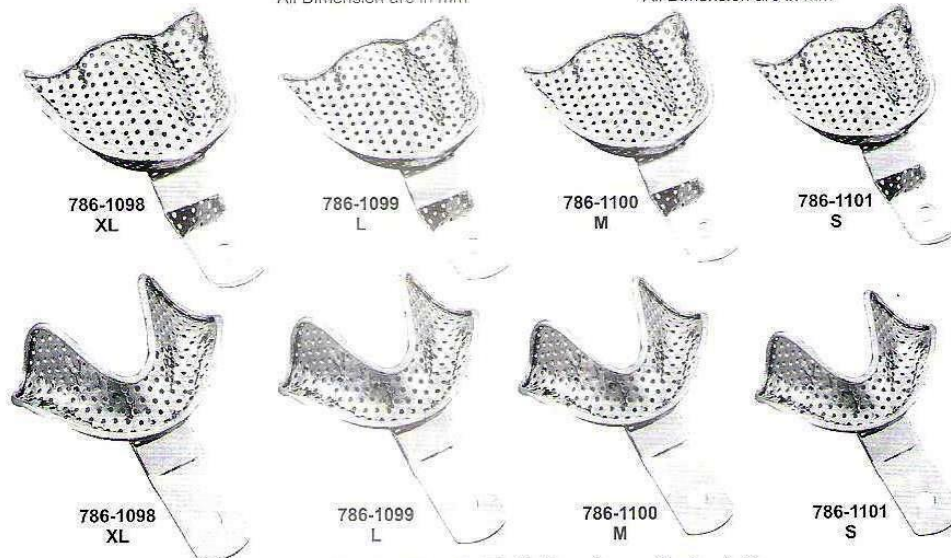
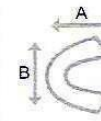

Perforated Full Denture Set of 8 786-018wa

Stainless Steel Impression Trays Made of 18/8 Stainless Steel

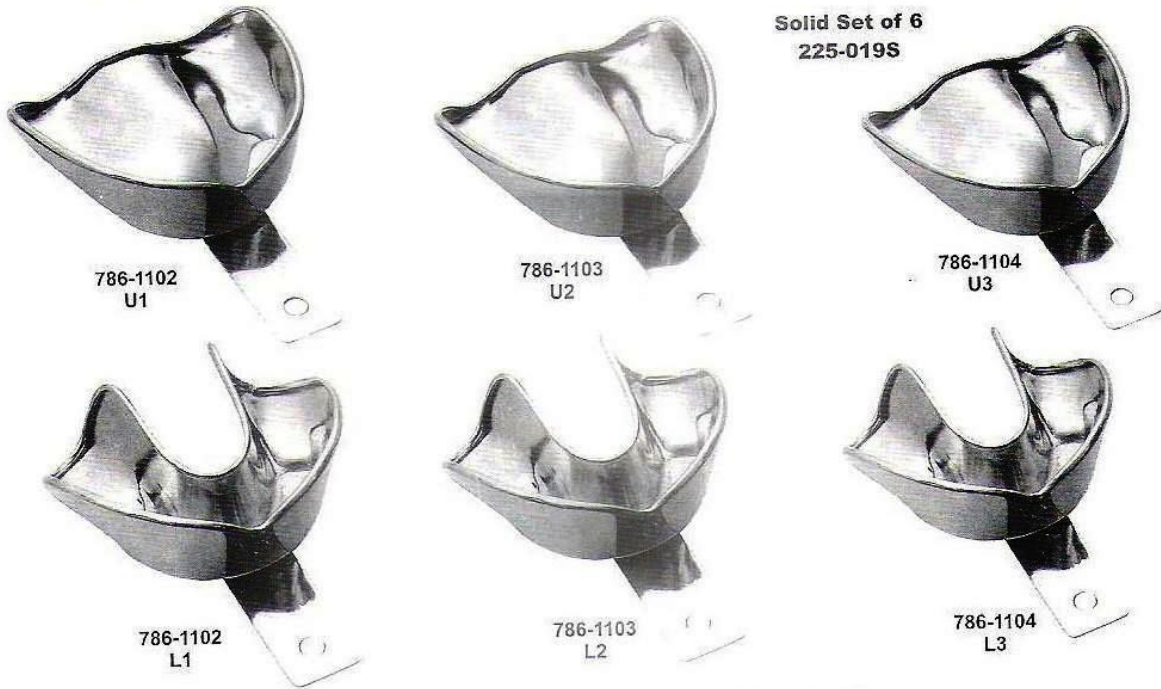

All the above impression trays are available in these 3 sizes

UPPER		U1	U2	U3
	A	67	64	57
	B	81	71	70

LOWER		L1	L2	L3
	A	60	57	54
	B	81	79	76

All Dimension are in mm

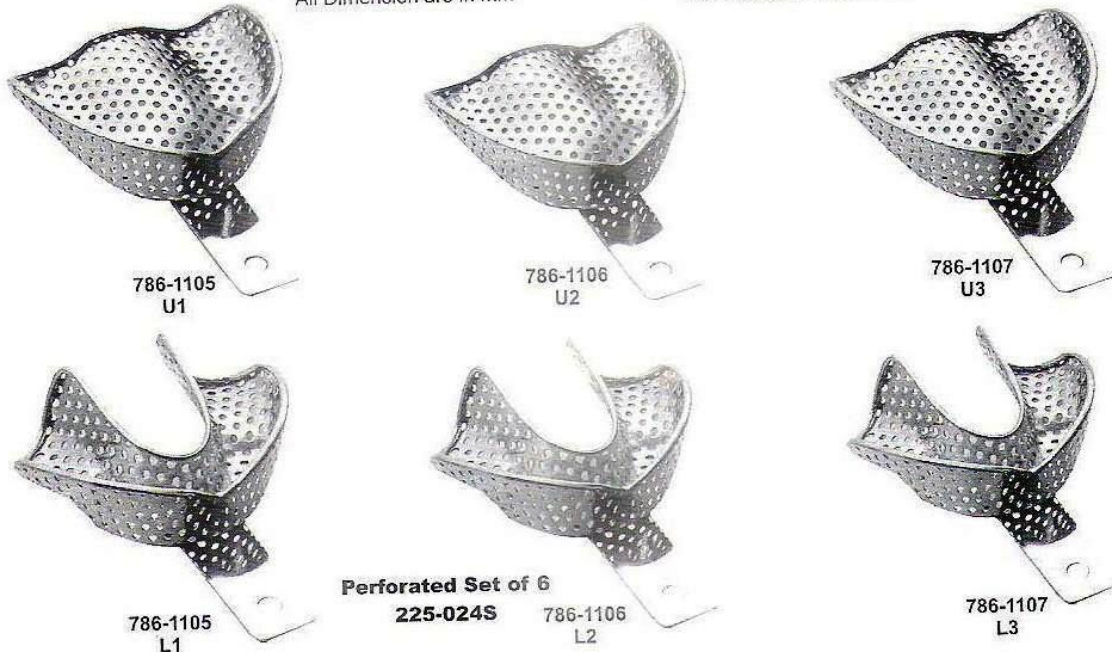

Stainless Steel Impression Trays Made of 18/8 Stainless Steel

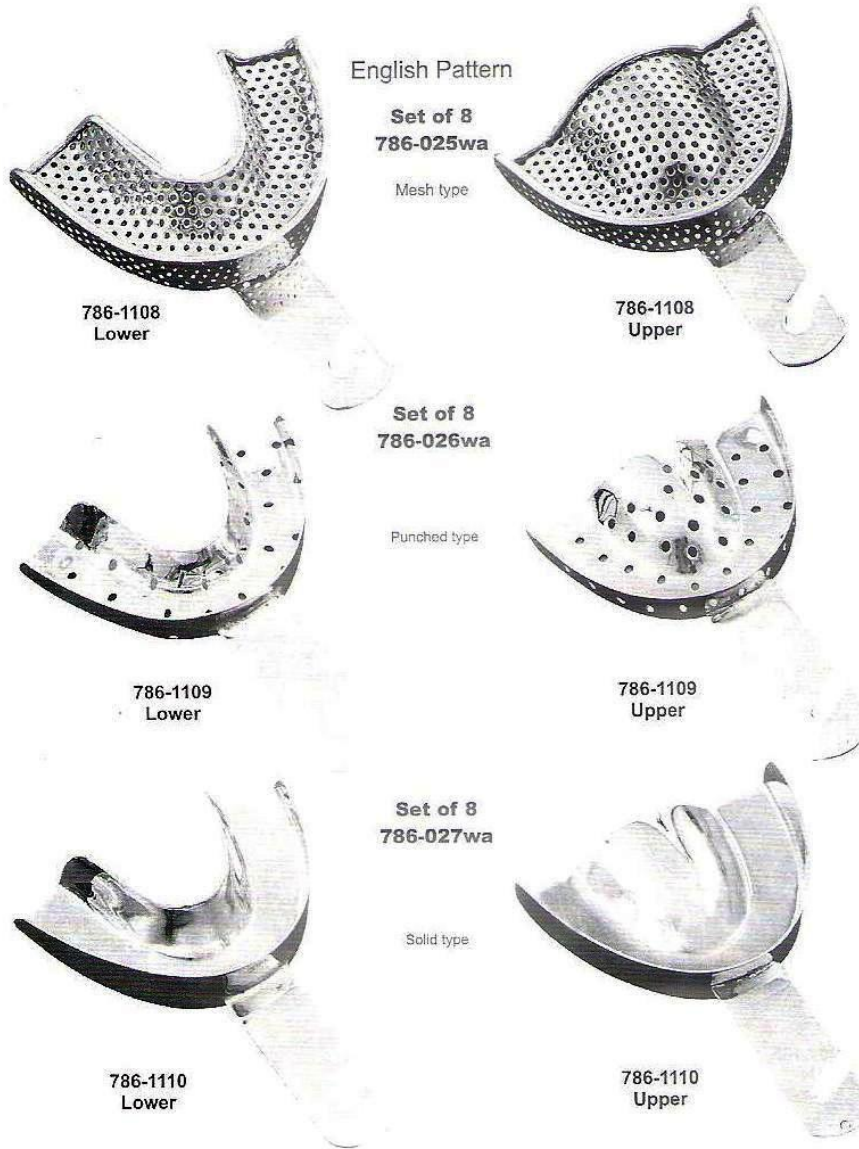

All the above impression trays are available in these 4 sizes

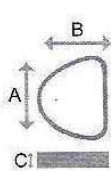

UPPER	Size	A	B	C
	0	67	50	12
	1	72	51	13
	2	78	55	15
	3	80	58	15

All Dimension are in mm

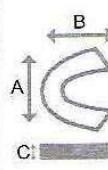

LOWER	Size	A	B	C
	0	70	50	14
	1	77	51	15
	2	79	55	15
	3	80	60	17

All Dimension are in mm

Stainless Steel Impression Trays Made of 18/8 Stainless Steel

**Solid Full Denture Set of 8
786-028wa**



786-1111
XL

786-1112
L

786-1113
M

786-1114
S

786-1111
XL

786-1112
L

786-1113
M

786-1114
S

All the above impression trays are available in these 4 sizes

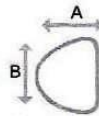

UPPER		XL	L	M	S
	A		70	67	64
B		79	76	70	73

All Dimension are in mm



LOWER		XL	L	M	S
	A		64	64	60
B		86	70	73	70

All Dimension are in mm

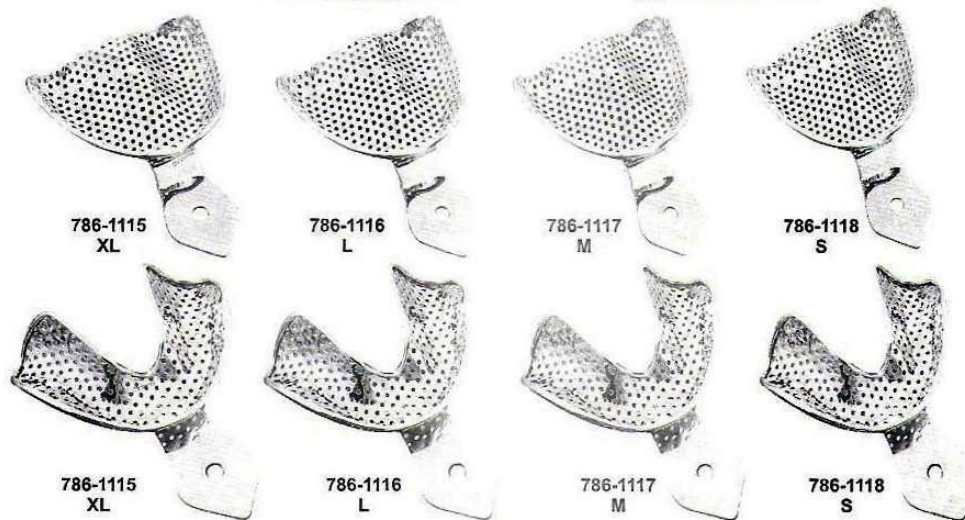

786-1115
XL

786-1116
L

786-1117
M

786-1118
S

786-1115
XL

786-1116
L

786-1117
M

786-1118
S

**Perforated Full Denture Set of 8
786-035wa**

Stainless Steel Impression Trays Made of 18/8 Stainless Steel

English Pattern



**Solid Full Denture Set of 8
786-036wa**



**Upper Sizes 0,1,2,3,
Depth of the tray 15,9 mm
Height of palate 12,5 mm**

**Lower Sizes 0,1,2,3,
Depth of the tray 12,9 mm**

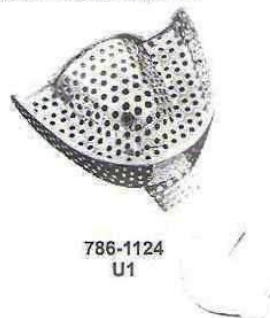

**Perforated Full Denture Set of 8
786-043wa**

**Stainless Steel Impression Trays
Made of 18/8 Stainless Steel**

Impression trays for crown & bridge work

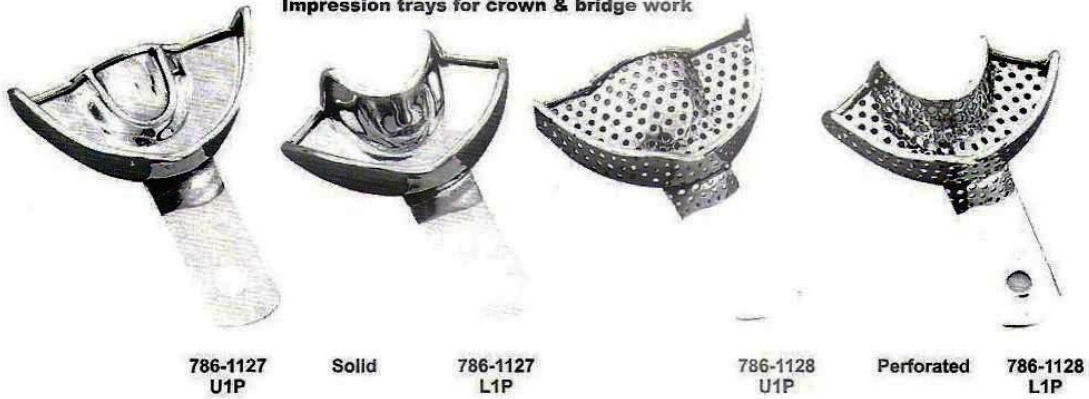

786-1127
U1P

Solid

786-1127
L1P

786-1128
U1P

Perforated

786-1128
L1P



Perforated

786-1129
For upper right jaw
For lower left jaw

786-1130
For upper left jaw
For lower right jaw

786-1131
Adjustable
Perforated

786-1131A
Adjustable
Solid

Available in 4 Sizes
1.....44 mm
2.....55 mm
3.....60 mm
4.....65 mm

Also available in Solid pattern

- ▶ **Längere Haltbarkeit** durch extraharten Spezialstahl
- ▶ **Exakteres Arbeiten** durch präzise Formgebung
- ▶ **Longer life** through very hard high-grade steel
- ▶ **Better work results** through precise form of pliers

- ▶ **Solidité supérieure** par acier inoxydable extra-dur
- ▶ **Travail plus exact** par un précis façonnage des pinces

- ▶ **Solidez superior** por acero inoxidable extra-duro
- ▶ **Trabajo más exacto** por un modelado preciso de las alicates



41.5012

13 cm , gerieft
 13 cm , serrated
 13 cm , striée
 13 cm , estriado



41.5014-1

13 cm , gerieft
 13 cm , serrated
 13 cm , striée
 13 cm , estriado

Flachzangen
Flat nose pliers
Pincas plates
Alicates de picos chatos

41



41.5024
13 cm, gerieft
13 cm, serrated
13 cm, striée
13 cm, estriado



41.5023
13 cm, glatt
13 cm, smooth
13 cm, lisse
13 cm, liso



41.5402 GOSLEE
13 cm, glatt-gerieft, Fig. 136
13 cm, smooth-serrated, Fig. 136
13 cm, lisse-striée, Fig. 136
13 cm, liso-estriado, Fig. 136

Flachzangen
Flat nose pliers
Pinces plates
Alicates de picos chatos



41

41.5022

12,5 cm , gerieft
12,5 cm , serrated
12,5 cm , striée
12,5 cm , estriado

41.5026

14 cm , gerieft
14 cm , serrated
14 cm , striée
14 cm , estriado

41.5351 FREVERT

12 cm , gerieft
12 cm , serrated
12 cm , striée
12 cm , estriado

Drahtbiegezaugen
Wire bending pliers
Pinces à courber les fils
Alicates para doblar alambre

41



41.5153 ADAMS
 Fig. 64, 14,5 cm

41.5153F CARBIDE COATING
 Mit Hartmetall beschichtet
 With extra-hard coating
 Avec enduit extra-dur
 Con capa extra-dura

41.5155 TC GOLD
 mit extra-harten Einsätzen
 with extra-hard inserts
 avec mors extra-durs
 con filos extra-duros



41.5152 ADAMS
 12 cm

41.5152F CARBIDE COATING
 Mit Hartmetall beschichtet
 With extra-hard coating
 Avec enduit extra-dur
 Con capa extra-dura

41.5154 TC GOLD
 mit extra-harten Einsätzen
 with extra-hard inserts
 avec mors extra-durs
 con filos extra-duros



41.5182 ANGLE
 12 cm, Bogenbiegezauge
 12 cm, Arch forming pliers
 12 cm, pince à courber les arcs
 12 cm, alicates para doblar arcos

Drahtbiegezaugen
Wire bending pliers
Pinces à courber les fils
Alicates para doblar alambre

41



Drantdiegezangen
 Wire bending pliers
 Pinces à courber les fils
 Alicates para doblar alambre



41.5179 JARABAK
13 cm

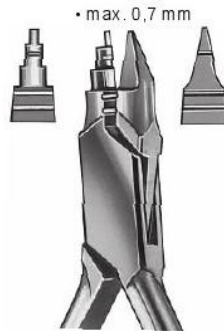

41.5178 YOUNG
14 cm, Fig. 74

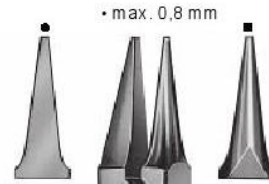

41.5169
16 cm, Fig. 65



41.5167 LIGHT-WIRE
12 cm



41.5168
14 cm

41.5169-20 TC GOLD
 • mit extra-harten Einsätzen
 with extra-hard inserts
 avec mors extra-durs
 con filos extra-duros



41

Drahtbiegezangen
Wire bending pliers
Pincès à courber les fils
Alicates para doblar alambre

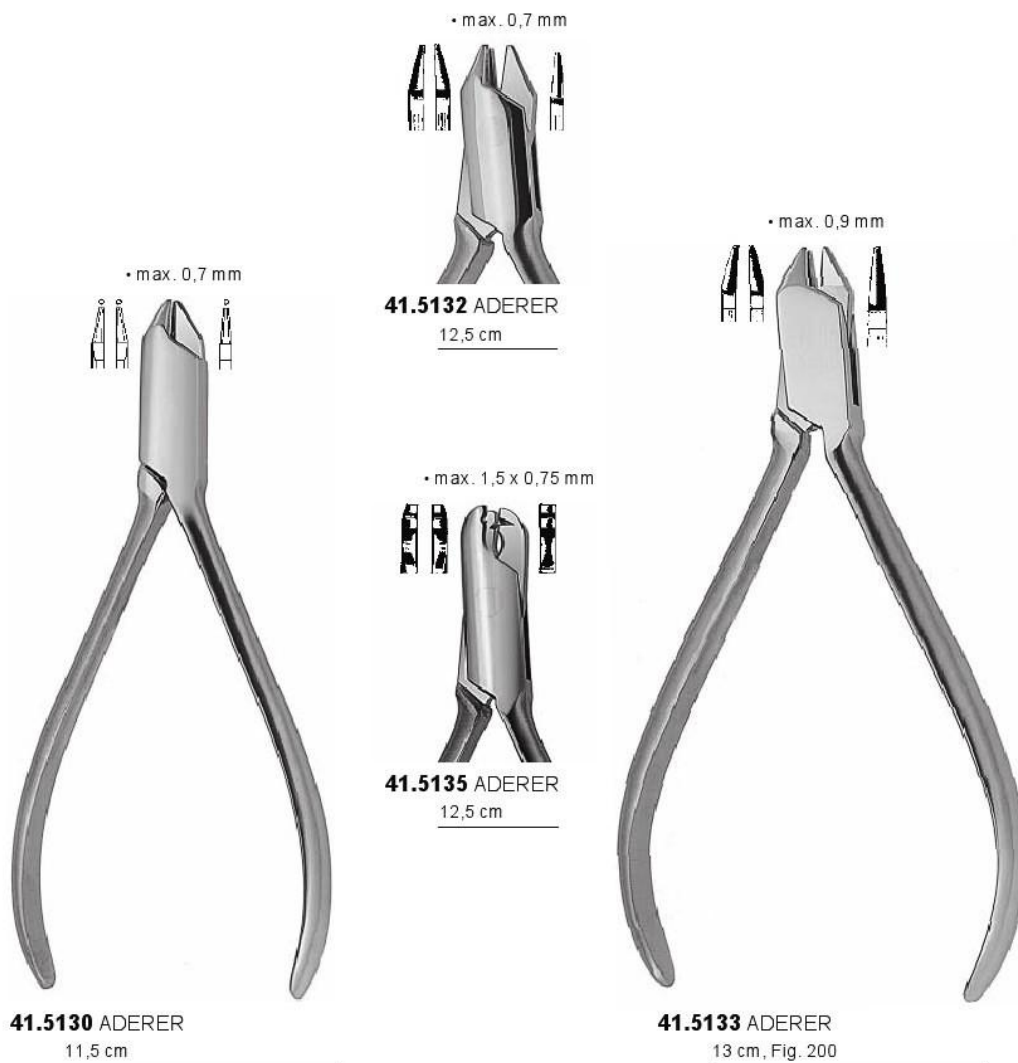

Drahtbiegezangen
Wire bending pliers
Pinces à courber les fils
Alicates para doblar alambre

41



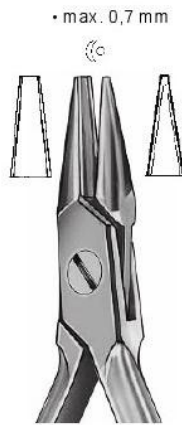

41.5142
13,5 cm



41.5143
13,5 cm



41.5144 SCHWARZ
13,5 cm



Drahtbiegezaugen
Wire bending pliers
Pinces à courber les fils
Alicates para doblar alambre

-  **41.5125 MC KELLOPS**
-  **41.5126 MC KELLOPS**

• max. 1,5 mm



MC KELLOPS
17 cm, Bügelbiegezaugen
17 cm, bar bending pliers
17 cm, pinces à plier les barres
17 cm, alicates para doblar barras

Klammerbiegeezangen
Clasp bending pliers
Pinces à courber les crochets
Alicates para doblar ganchos

41

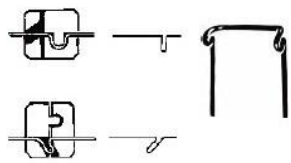

• max. 0,7 mm

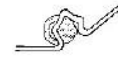

• max. 0,7 mm

• max. 0,7 mm



41.5188

13,5 cm, für Adams-Klammern
 13,5 cm, for Adams clasps
 13,5 cm, pour crochets de Adams
 13,5 cm, para ganchos de Adams



41.5190

11,5 cm, Pfeilformzange
 11,5 cm, arrow head clasp forming plier
 11,5 cm, pince à former les flèches
 11,5 cm, alicata para formar les flechas

41.5192

11,5 cm, Pfeilknickzange
 11,5 cm, arrow head clasp bending plier
 11,5 cm, pince à plier les flèches
 11,5 cm, alicata para doblar les flechas

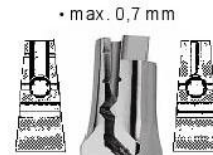

• max. 0,7 mm



41.5191

13 cm, kombiniert
 13 cm, combined
 13 cm, combinées
 13 cm, combinado

Universalzangen
 Universal pliers
 Pinces universelles
 Alicates universales

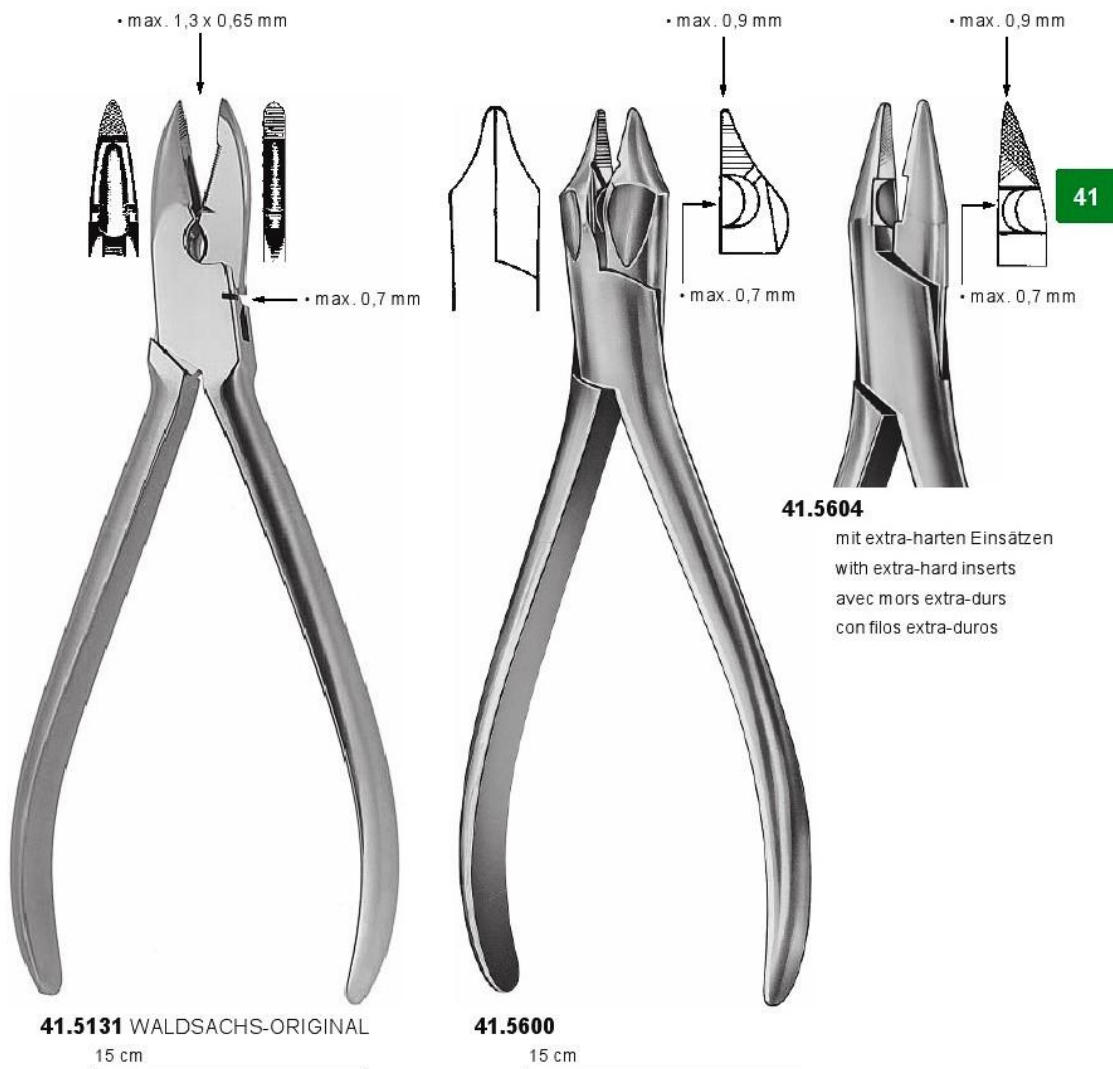

Drahtschneidezangen
Wire cutters
Pinces coupantes
Alicates para cortar alambre

TC GOLD rosttfrei, sterilisierbar, mit extra-harten Einsätzen
 stainless, sterilisable, with extra-hard inserts
 inoxydable, sterilisable, avec mors extra-durs
 inoxidable, esterilizable, con filos extra-duros

41



41.5255
 14 cm, verchromt, nicht sterilisierbar
 14 cm, chrome-plated, not sterilisable
 14 cm, chromée, non-sterilisable
 14 cm, cromada, no esterilizabile

41.5268
 Werkzeugqualität, nicht sterilisierbar
 Tool quality, not to be sterilized
 Qualité d'outil, non-sterilisable
 Calidad de herramienta, no esterilizabile

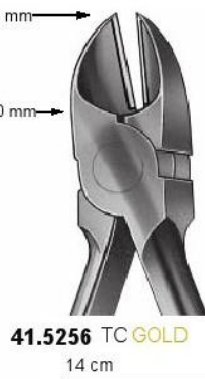

41.5256 TC GOLD
 14 cm



41.5254 TC GOLD
 12 cm



41.5260 TC GOLD
 18 cm

Drahtspannzange
For wire ligatures
Pour ligatures de fil
Para ligaduras de alambre



41.2024 TC GOLD
15 cm, Hartmetalleinsätze
15 cm, Tungsten carbide inserts
15 cm, Pointes en tungstène
15 cm, Puntas de tungsteno



41.2053
MATHIEU
14 cm

41.2057 TC GOLD
Hartmetalleinsätze
Tungsten carbide inserts
Pointes en tungstène
Puntas de tungsteno

41

Ligaturinstrumente
Ligature instruments
Instruments à ligature
Instrumentos para ligaduras



Bandinstrumente
Band instruments
Instruments à bagues
Instrumentos para bandas



41.4948 OLIVER-JONES
15 cm, Bandabnehmezange
15 cm, band removing pliers
15 cm, pince à enlever les bagues
15 cm, alicate para sacar bandas



41.4950
15 cm, Bandaufsetzer
15 cm, band setter
15 cm, instrument à adapter
15 cm, adaptor de bandas



41.4952 MERSHON
15 cm, Bandandrücker
15 cm, band pushers
15 cm, instrument à pousser
15 cm, empujadores de bandas

41

Konturzangen
Contouring pliers
Pinces à bouteroller
Alicates para contornear

41



41.5351 FREVERT
12 cm

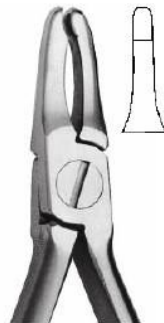

41.5444 JOHNSON
13 cm, Fig. 114



41.5462 GORDON
12,5 cm, Fig. 137



41.5466 REYNOLD
12,5 cm, Fig. 115

A			
Abdrucklöfle	184-191	Bone spreader	77
Abfallbehälter für Watte	92	Bowdler-Henry's wundhaken	83
Abhalter	84-85	Bowmann , Knopfsonden	80
Abnehmer für Kronen	179-182	Boynton , Nadelhalter	90
Abnehmezange für Kupferringe	177	Brenner, Spiritus	172
Absaugrohre	83	Buchwald , Zungenspatel	86
Achatspatel	158	Bügelbiegezangen	199
Adams Drahtbiegezangen	195	C	
Adams Klammerbiegezange	201	Castroviejo , Nadelhalter	87
Aderer , Drahtbiegezangen	198-199	Castroviejo , Zirkel	94
Adson , anatomische Pinzetten	56	Chirurgische Hämmer	74
Adson , chirurgische Pinzetten	58	Chirurgische Kürett	69
Ainsworth , Kofferdam-Lochzange	160	Chirurgische Nadeln	91
Allis , Zahnfleischfaßzang	61	Chirurgische Pinzetten	58-59
Amalgampistolen	138-139	Chirurgische Scheren	55
Amalgamschneider	152-155	Chompret , Syndesmotome	35
Amalgamstopfer	135	Cleoid-Discoid , Modellierinstrumente	154
Ampullenspritzen	93	Cogswell , Saugkanüle	83
Anatomic , Abdrucklöffel	184-190	Cohen , Gewebezängchen	126
Anatomische Pinzetten	56-57	Coleman , Wurzelheber	38
Andrücken, Band	206	College , Zahnpinzetten	98-100
Angle , Bogenbiegezange	195	Columbia , Universalküretten	121
Angle , Drahtbiegezange	196	Composite-Instrumente	149-151
Apical , Wurzelheber	34	Contrawinkel-Füllungsinstrumente	140-143
Arterienklemmen	60	Coupland , Wurzelheber	33
Artikulationspapierpinzette	178	Crane-Kaplan	59-127
Atraumatische Pinzetten	57	Crane-Kaplan , Zahnreinig	112
Aufwachsinstrumente	171	Crile , Nadelhalter	88
B		Crile-Ryder , Nadelhalte	89
Backhaus , Tuchklemmen	61	Crile-Wood , Nadelhalte	89
Bandinstrumente	206	Zangen für Prothetik und Orthodontie	192-207
Barry , Wurzelheber	40	Cryer , Wurzelheber	39
Baumgartner , Nadelhalter	88	Cryer , Zahnzangen	21-23
Beale , Modellierinstrument	170	Cumine , Zahnreiniger	111
Beebee , Kronenschere	176	Cushing , Pinzetten	57-59
Behälte	92	D	
Bein , Wurzelheber	31	Darby-Perry , Exkavatoren	135
Bennet , Füllungsinstrumen	146	Dean , Zahnfleischschere	53
Beyer , Hohlmeißelzange	28	DeBaKey , atraumatische Pinzetten	57
Black , Exkavatoren	136	DeBaKey , Nadelhalter	89
Black , Füllungsinstrumente	141-145	Denhart , Mundsperrer	86
Black , Gingivalrandschräger	130-131	Diamantierte Extraktionszangen	13-16
Black , Modellierinstrumente	154	Diamantierte Zahnpinzette	98-101
Black , Schmelzmeißel	130	Discoid-cleoid , Modellierinstrumente	154
Blake , Klingenhalter	47	Dosen, Nadel	91
Blechscheren	176	Doyen, Nadelhalte	88
Blumenthal , Hohlmeißelzange	27	Doyen-Molt , Mundsperrer	86
Böhler , Hohlmeißelzange	28	Drahtbiegezangen	192-202
Böhm , Teleskopkronenzangen	183	Drahtschneidezangen	203
Bogenbiegezange	195	Drahtspannzangen	88-90-204-205
		Drehmeißel	43
		Dycal , Füllungsinstrumente	143
		E	
		Economy , Mundspiegelgriff	96
		Ehricke , Abdrucklöffel	185-188
		Elevatorien	65-66
		Endodontie-Instrumente	162-166
		Ermer , Wachsmesser	172
		Epker , Osteotome	73
		Exkavatoren	132-136-162
		Extraktionszange	5-24
		Extraktionszangen, diamantiert	13-16
		F	
		Fadenschere	50-54
		Fadenstopfer, Retraktions	177
		Fahnenstock , Wachsmesser	173
		Farabeuf , Wundhaken	82
		Farbringe für Gracey-Kürett	116
		Fedi , Parodontal-Meißel	71
		Feilen, Knochen	69
		Feilen, Parodontal	126
		Fingerschützer	85
		Fissurenzieher	151-154-156
		Fistel Sond	80
		Flachmeißel	70-73
		Flachzangen	192-194
		Flagg , Zahnpinzetten	101
		Flohr , Wurzelheber	34
		Folienschere	52-176
		Fox , Gewebepinzetten	59
		Fox , Raspatorien	67
		Frahm , Modellierinstrument	155-170
		Frazier , Saugkanüle	83
		Freer , Elevator	66
		Freer , Flachmeißel	71
		Freer , Raspatorien	66-68
		Frevert , Flachzange	194-207
		Friedman , Hohlmeißelzange	25
		Füllungsentferner	131
		Füllungsinstrumente	140-151
		Füllungsinstrumente für Composite	149-151
		Füllungsinstrumente für Wurzelkanal	163-165
		Furchungsküretten	120
		Furkationssonden	106
		Furrer , Kupferringabnehmeza	177
		G	
		Gefäßklemm	60
		Geurtsen , Composite-Schaber	149
		Geurtsen-Günay , Furchungsküretten	120
		Gewebehaken	81
		Gewebepinzetten	59
		Gewebezängche	126
		Gillet , Exkavator	132
		Gillies , chirurgische Pinzette	58
		Gillies , Wundhäkchen	81
		Gingivalrandschrä	130-131

Gingivektomie-Besteck.....	127	Hyllin , Wurzelheber.....	33	Knochenschneidezangen.....	27
Gingivektomie-Instrumente.....	47-125-127	Hyllin-Le Cron , Modellierinstrument... 204		Knopfsonden.....	80
Gingivektomie-Scheren.....	49-53	I		Kocher , Wundhaken.....	83
Gipsmesser.....	174	Ilic , Gewebezügchen.....	126	Kofferdam-Instrumente.....	160-161
Gipsschneidezange.....	174	Implantologie-Abdrucklöffel.....	191	König, Raspatorien.....	65
Gipsspatel.....	175	Injektionsspritzen.....	93	Konturzangen.....	207
Glick , Wurzelkanal-Stopfer.....	165	Instrumente für Aufwachste.....	171	Kopp , Wurzelheber.....	37
Goldmann-Fox	114-122-125-127	Instrumente, Band.....	206	Kornzangen.....	61
Goldmann-Fox, Parodontologie-Set... 127		Instrumente, Composite.....	149-151	Krallenheber.....	41
Goldmann-Fox , Zahnfleissscheren 49-52		Instrumente, Füllungs.....	140-151	Kramer , chirurgische Küretten.....	69
Gordon , Konturzange.....	207	Instrumente, Gingivektomie.....	125-127	Kramer-Nevins , Parodontal-Meißel.....	71
Goslee , Flachzange.....	193	Instrumente, Keramik.....	169	Kramponzangen.....	202
Gracey Color , Küretten.....	118	Instrumente, Ligatur.....	204-205	Kronenabnehmer.....	179-181
Gracey , Küretten.....	115-117-119-124	Instrumente, Modellier- für Füllungen... 151-155		Kronenabnehmezangen.....	182
Gracey , Miniatur-Küretten.....	119	Instrumente, Modellier- für Prothetik ... 168-171		Kronenscheren.....	176
Griffe, Mundspiegel.....	96	Instrumentenbehälte.....	92-128	Küretten, Alveolar.....	62-64
Griffe für Paro-Instrumente.....	123	Ivory , Amalgampistolen.....	139	Küretten, Furchungs.....	120
Griffe für Skalpellklingen.....	45-47	Ivory , Kofferdam-Klammern.....	161	Küretten, Gracey.....	115-117-119-124
Gritman , Gipsmesser.....	174	Ivory , Kofferdam-Lochzange.....	160	Küretten, Gracey Color.....	118
Gross , Kornzangen.....	61	Ivory , Matrizenspanner.....	137	Küretten, Miniatur.....	119
Guy , Füllungsinstrumente.....	145	Ivory , Separator.....	137	Küretten, Sinus Lift.....	76
Guy , Zahnzange.....	5	Ivory , Stiftzieher.....	162-178	Küretten, Universal.....	121-122-124
H		Iwanson , Zehntelmaß.....	178	Küretten, Wechselgriff.....	123-124
Hämmer, chirurgische.....	74	J		Kupferingabnehmezange.....	177
Hammer, Plombier.....	139	Jacobson , Nadelhalter.....	88	L	
Hämmer für Techniker.....	172	Jacquette , Zahnreiniger.....	112	Laborzangen.....	192-207
Halsted-Mosquito , Arterienklemmen... 60		Jarabak , Drahtbiegezange.....	197	Ladmore , Füllungsinstrument.....	144
Beyer , Hohlmeißelzange.....	28	Johnson , Konturzange.....	207	La Grange , Zahnfleissschere.....	49-51
Halter für Mini-Klingen.....	45	Jones , Tuchklemme.....	61	Lampe, Spiritus.....	172
Handform Mundspiegelgriffe.....	96	Joseph , Zahnfleissscheren.....	53	Landgraf , Zahnpinzette.....	100
Hartmann , Arterienklemmen.....	60	K		Langenbeck , Fingerschützer.....	85
Hauer , Parodontometer.....	107	Kanalscheren.....	176	Langenbeck , Wundhaken.....	82
Hautzangen.....	126	Kanülen, Saug.....	83	Langer , Universalküretten.....	121
Heat transmitter.....	163	Kelly , Arterienklemmen.....	60	Lecluse , Wurzelheber.....	40
Heber, Wurzel.....	29-42	Kelly , Zahnfleissscheren.....	49-53	Le Cron , Modellierinstrumente.....	169
Heber, Wurzelfragment.....	42	Keramikinstrumente.....	169	Lessmann , Wachsmesser.....	173
Heidbrink , Wurzelheber.....	42	Kilner , Wundhaken.....	81	Lexer-Mini , Osteotom.....	72
Heidemann , Spatel.....	148-150	Kinder-Zahnzangen.....	18-20-23	Lichtenberg-Ryder , Nadelhalter.....	90
Helfgen , Abdrucklöffel für die Implantologie 191		Kirkland , Parodontalmesser.....	125	Lichtenstein , Spatel für Abdruckmassen... 175	
Hemingway , Scharfe Löffel.....	63	Klammern, Kofferdam.....	161	Lift-ex , Kronenabnehmer.....	180
Hilger , Abhalter.....	85	Klammerzange, Kofferdam.....	161	Ligaturscheren.....	50-54
Hirschfeld , Parodontalfleilen.....	126	Klammerbiegezangen.....	195-202	Ligaturzangen.....	204-205
Hirtenstab, Kronenabnehmer.....	179	Klein , Zahnzangen für Kinder.....	20	Light-Wire, Drahtbiegezange.....	197
Hoe , Zahnreiniger.....	114-127	Klemmen.....	60-61	Lindo-Levien , Wurzelheber.....	36
Hohlkehlezangen.....	200	Klingen für Skalpelle.....	45-46	Littauer , Ligaturschere.....	54
Hohlmeißel.....	72	Klingenentferner.....	47	Lochzange, Kofferdam.....	160
Hohlmeißelzangen.....	25-28	Knabberzangen.....	25-28	Locklin , Zahnfleissschere.....	53
Hollenback , Füllungsinstrument.....	145	Knochenerweiterungssystem.....	77	Löffel, Abdruck.....	184-191
Hollenback , Modellierinstrumente... 152-168		Knochenfeilen.....	69	Löffel, Scharfe.....	62-64
Holst , Zahnsonde.....	102	Knochenhaltepinzette.....	59	Lötpinzette.....	172
Hopson , Füllungsinstrumente.....	145	Hyllin , Modellierinstrument.....	169	London-College , Zahnpinzetten... 98-100	
Hornhammer.....	172			London-Hospital , Wurzelheber.....	38
How , Ligaturzangen.....	205			Lucas , Flach- und Hohlmeißel.....	72
Hygienist , Zahnreiniger.....	110-111-123			Lucas , Scharfe Löffel.....	64

Luer-Friedmann, Hohlmeißelzang 26
Luks, Wurzelkanal-Stopfer 164
Luniatschek, Tamponstopfer 80
Luxator, Wurzelheber 29-30

M

Markierungspinzetten 59-127
 Markierungsringe für Gracey-Küretten 116
Martini, Scharfer Löffel 62
Mathieu, Nadelhalter 90
Mathieu-Eiselsberg, Nadelhalter 90
 Matrizenpanner und Matrizen 137
Maty, Vestibulum-Haken 84
Mayo-Hegar, Nadelhalter 89
McCall, Universalküretten 122-124
McCall, Zahnreiniger 113
McKellops, Bügelbiegezangen 200
Mead, Chirurgischer Hammer 74
 Medikamententräger 80
Medium, Zahnsonden 105
 Meißel 70-73
 Meißel, Schmelz- 130
Meriam, Zahnpinzetten 101
Mershon, Bandandrücker 206
 Messer, Parodontal- 47-125-127
 Messer, Gips- 174
 Messer, Wachs- 172-173
 Meß-Instrumente 94-178
Method, Behälter 92
Metzenbaum, Präparierscheren 55
Micro, Nadelhalter 18-88
Micro, Resektionsspiegel 37
Micro, Zahnfleischscheren 51
Micro-Adson, Pinzetten 56-58
Middeldorpf, Wangenhalter 85
Miller, Artikulationspapierpinzette 178
Miller-Colburn, Knochenfeilen 69
Mini-Friedman, Hohlmeißelzangen 25
 Mini-Klingen 45
Minnesota, Mundwinkelhalter 79
Mitchell, Modellierinstrument 170
Mitchell, Osteotrimmer 111
 Modellierinstrumente für Füllungen 151-155
 Modellierinstrumente für Prothetik 168-171
Molt, Mundsperrerr 86
Molt, Raspatorien 67
Morell, Kronenabnehmer 179
Morse, Zahnreiniger 113
Mortonson, Füllungsinstrument 145
Mosquito, Klemmen 60
Müller-Senn, Wundhaken 81
 Mundsperrerr 86
 Mundspiegel 97
 Mundspiegelgriffe 96
 Mundwinkelhalter 85

N

Nabers, Parodontal-Sonde 106
 Nadeldose 91
 Nadelhalter 87-90
 Nähmandel 91
 Nahtpinzette 57-91
 Nierenschalen 92
 Niethammer 172
Northbent, Ligaturschere 54
Noyes, Zahnfleischscheren 53
Nyström, Matrizenpanner 137
Nyström, Modellierinstrumente 153-168

O

Obwegeser, Raspatorien 65
 Ochsenbein, Parodontal-Meißel 70
 Okklusionslöfle 190
Oliver-Jones, Bandabnehmezange 208
Optiflex, Zahnsonden 104-105
Orban, Parodontalmesser 125
Oringer, Lippensterrer und Wangenhalter 86
 Osteotome 72-73
 Orthodontische Zangen 192-207
 Osteotrimmer 111

P

Parallelklingen-Skalpellgriffe 47
Parmly, Zahnzange 21
 Parodontal-Besteck 127
 Parodontalfeile 126
 Parodontal-Meißel 70-71
 Parodontalmesser 47-125-127
 Parodontal-Sonden 106-107
 Parodontomete 107
Partsch, Flachmeißel 72
Partsch, Raspatorien 66
Perigrip, Abdrucklöffel 184
 Periotome 75
Perry, Zahnpinzetten 100
 Pfeilform- und Pfeilknickzangen 201
 Pinzetten, anatomische 56-57
 Pinzette, Artikulationspapier- 166
 Pinzetten, chirurgische 58-59
 Pinzetten, Gewebe- 59
 Pinzette, Löt- 172
 Pinzette, Naht- 57-91
 Pinzetten für Silberspitzen 99-166
 Pinzetten, Taschenmarkierungs- 59-127
 Pinzetten, Zahn- 98-101
P.K Thomas, für Aufwachstechnik 171
 Planatoren, Füllungsinstrumente 143
 Plombierhamme 139
 Polierer 151-156-157
Pott, Wurzelheber 41

Präparierscheren 55
Prichard, Raspatorien 68
Protector, Sterilisierrahmen 128
 Prothetische Zangen 192-207
 Pulpakanal-Excavatoren 132-162

Q

Quick-Change, Wechselgriff und -spitzen 123-124
Quinby, Zahnfleischschere 52

R

Rahmen, Kofferdam- 160
 Rahmen, Sterilisier- 128
 Ramushaken 83
 Rasierklingenthaler 45
 Raspatorien 65-68
Read, Zahnzange 7
Reeb, Okklusionslöffel 190
 Reiniger, Zahn- 110-114-123-124
 Resektions-Spiegel 97
 Retraktionsfadenstopfer 177
Reynold, Konturzange 207
Rhodes, Parodontal-Meißel 70
Rhodium, Mundspiegel 97
Riegner, Modellierinstrument 170
Rollet, Wundhaken 81
Rotondo, 140-141-143-147-148
Rotondo, Exkavatoren 132
Routurier, Zahnzangen 11
Roux, Wangenhalter 85
 Rundzangen 196

S

Saugkanülen 83
 Schaber, Composite- 149
Schar, Wundhaken und Wangenhalte 82
 Scharfe Löffel 62-64
 Scaler 110-114-123-127
 Scheren, chirurgische 55
 Scheren, Präparie 55
 Scheren, Folien- 51-176
 Scheren, Kronen- und Blech- 176
 Scheren, Ligatur- 50-54
 Scheren, Zahnfleisch- 49-53
Schluger, Parodontalfeile 126
 Schmelzmeißel 130
 Schneidezangen, Gips- 174
 Schnitzinstrumente für Füllungen 151-155
Schwarz, Drahtbiegezange 200
 Seitenschneider 203
Seldin, Raspatorium 67
Seldin, Wurzelheber 39
Semken, anatomische Pinzetten 56

Semken , chirurgische Pinzetten.....	58	Tönnis , Nadelhalter.....	88	Wurzelzangen.....	8-12-14-16-17
Senn-Green , Wundhaken.....	81	Tofflemire , Matrizenspanner.....	137	Wurzelzangen, diamantiert.....	14-16-17
Senn-Müller Wundhaken.....	81	Tomes , Zahnzange.....	24	Y	
Separator.....	137	Towner , Zahnreiniger.....	114	Young , Drahtbiegezange.....	197
Serviettenhalter.....	96	Trays.....	92-128	Younger-Good , Universalküretten.....	122
Silberspitzeninstrumente.....	149	Treymann , Kronenabnehmer.....	179	Z	
Silberspitzenpinzette.....	99-166	Tuchklemmen.....	61	Zahle , Modellierinstrumente.....	169
Silikonmesser.....	170	U		Zahnpinzetten.....	98-101
Sinus Lift Küretten.....	76	Offenorde , Scharfe Löffel.....	62	Zahnreiniger.....	110-114-123-127
Sinusboden-Elevatoren.....	78-79	Universal, Kronenabnehmer.....	181	Zahnsonden.....	102-105
Skalpelle, Griffe und Klängen.....	45-47	Universalküretten.....	121-122-124	Zahnfleischfaßzange.....	61
Sonden, Zahn.....	102-105	Universal, Retraktionsfadenstopfer.....	177	Zahnfleisch-Scheren.....	49-53
Sonden, Parodontal.....	106-107	Universal, Zahnsonden.....	102-103	Zahnzangen, amerikanische Form.....	21-24
Sonden, Knopf.....	80	Universal, Zahnzangen.....	21-23-24	Zahnzangen, anatomischer Griff.....	13-16
Sonde, Wurzelkanal.....	105-162	Universal, Zangen für Prothetik und Orthodontie.....	202	Zahnzangen, diamantiert.....	13-16
Spatel für Abdruckmassen.....	175	V		Zahnzangen, englische Form.....	5-20
Spatel für Füllungen.....	141-151	Vestibulumhaken.....	84	Zahnzangen, Kinder.....	18-20-24
Spatel, Zement.....	158-159	Vignon , Modellierinstrument.....	155	Zange für Adams-Klammern.....	201
Spatel, Zungen.....	86	Volkman , Scharfe Löffel.....	62	Zange, Bandabnehme.....	206
Spencer , Ligaturscheren.....	54	W		Zange, Bogenbiege.....	195
Spiegel und -Griffe.....	96-97	WACD , Modellierinstrument.....	154	Zangen, Bügelbiege.....	199
Spina Nasalis -Haken.....	83	Wachsmesser.....	172-173	Zangen, Drahtbiege.....	192-202
Spirituslampe.....	172	Wagner , Zahnfleischschere.....	51	Zangen, Drahtschneide.....	203
Splitterzangen.....	17	Waldsachs-Original , Universalzange.....	202	Zangen, Drahtspann.....	88-90-214-205
Spreizer, Wurzelkanal.....	163	Wangenhalter.....	84-86	Zangen, Flach.....	192-194
Spritzen.....	93	Ward , Füllungsinstrumente.....	146	Zangen, Gewebe.....	126
Sterilisier-Rahmen.....	128	Ward , Modellierinstrumente.....	153-168	Zange, Gipsschneide.....	174
Sternberg , Wangenhalter.....	85	Warwick-James , Wurzelheber.....	38	Zangen, Hohlkehl.....	200
Stevens , Zahnfleischschere.....	50	Wasserspritze.....	93	Zangen, Hohlmeißel.....	25-28
Stieglitz , Zange für Wurzelfragmente.....	17	Wattebehälter.....	92	Zangen, Kinder.....	18-20-24
Stiftzieher.....	162-178	Wechselgriff, Küretten.....	123-124	Zangen, Knochenschneide.....	27
Stoke , Kofferdam-Klammerzange.....	161	Weingart , Ligaturzange.....	205	Zangen, Kofferdam.....	160-161
Stolley , Abdrucklöffel.....	190	West , Raspatorien.....	68	Zangen, Klammerbiege.....	195-202
Stopfer.....	140-146-149-151	Westcott , Polierer.....	156	Zangen, Kontur.....	207
Stopfer, Wurzelkanal.....	164-165	Weston , Zahnsonde.....	103	Zangen, Korn.....	61
Stopfer, Retraktionsfaden.....	177	WHO , Parodontal-Sonden.....	106	Zangen, Kronenabnehme.....	182
Stopfer, Tampon.....	80	Wieder , Zungendrücker.....	86	Zange, Kupferingabnehme.....	177
Sugarman , Gewebezüngchen.....	126	Wiland , Modellierinstrument.....	152	Zangen, Ligatur.....	204-205
Super-Cut , Zahnfleischscheren.....	48-53	Williams , Füllungsinstrumente.....	146	Zangen, Pfeilform- und Pfeilknick.....	201
Syndesmotome.....	35	Williams , Parodontal-Sonde.....	106	Zangen für Prothetik und Orthodontie.....	192-207
T		Williger , chirurgische Hämmer.....	74	Zangen, Rund.....	196
Tamponstopfer.....	80	Williger , Elevator.....	65	Zangen, Teleskopkronen.....	183
Tantal , Composite-Instrumente.....	149	Williger , Raspatorien.....	65	Zangen, Wurzel.....	8-12-14-16-17
Taschenmarkierungspinzetten.....	59-127	Williger , Scharfer Löffel.....	62	Zangen, Wurzelfragmente.....	17
Tasterzirkel.....	178	Winter , Wurzelheber.....	40	Zangen, Wurzelstift.....	166
Taylor , Pinzetten.....	57-59	Witzel , Wurzelzangen.....	17	Zangen, Zahn.....	5-24
Taylor , Zahnreiniger.....	112	Woodson , Füllungsinstrumente.....	146	Zange, Zahnfleischfaß.....	61
TC-Pinzetten.....	54	Wundhaken.....	81-83	Zehntelmaß.....	178
TC-Scheren.....	50-52	Wundsonden.....	80	Zementspatel.....	158-163
Technikzangen.....	192-207	Wurzelheber.....	29-42	Zirkel.....	94
Teleskopkronenzangen.....	183	Wurzelkanalinstrumente.....	162-166	Zungensspatel.....	86
Thomas P.K. , für Aufwachstechnik.....	171	Wurzelstiftzange.....	166	Zylinder-Ampullen-Spritzen.....	93
Thorpe , Zahnreiniger.....	110				

A

Adams , clasp bending pliers.....	201
Adams , wire bending pliers.....	195
Adapters, band.....	206
Aderer , wire bending pliers.....	198-199
Adson , dissecting forceps.....	56
Adson , tissue forceps.....	58
Agate spatulas.....	158
Ainsworth , punch forceps.....	160
Alcohol lamps.....	172
Allis , gum seizing forceps.....	61
Alveolar curettes.....	62-64
Amalgam carriers.....	138-139
Amalgam carvers.....	152-155
Amalgam pluggers.....	140-146
Anatomic, impression trays.....	184-190
Angle , arch forming pliers.....	195
Angle , wire bending pliers.....	196
Apical , root elevators.....	34
Applicators, medicine.....	80
Applicators, tampon.....	80
Arch forming pliers.....	195
Arrowhead clasp bending and forming pliers.....	201
Artery forceps.....	60
Articulation paper forceps.....	178
Atraumatic forceps.....	57

B

Backhaus , towel clips.....	61
Band instruments.....	206
Bar bending pliers.....	200
Barry , root elevators.....	40
Baumgartner , needle holders.....	88
Beale , carvers.....	170
Beebee , crown scissors.....	176
Bein , root elevators.....	31
Bennet , filling instruments.....	146
Beyer , rongeur forceps.....	28
Black , enamel chisels.....	130
Black , excavators.....	136
Black , filling instruments.....	141-145
Black , gingival margin trimmers.....	130-131
Black , carvers.....	154
Blade removers.....	47
Blades for scalpel.....	45-46
Blake , blade holders.....	47
Blumenthal , rongeur forceps.....	27
Bhler , rongeur forceps.....	27
Böhm , pliers for telescope crowns.....	183
Bone chisels and gouges.....	70-73
Bone curettes.....	62-64
Bone cutting forceps.....	27
Bone files.....	69

Bone holding forceps.....	59
Bone spreaders.....	77
Bowdler-Henrys retractor.....	83
Bowls, kidney.....	92
Bowmann , probe.....	80
Boynton , needle holders.....	90
Brewer , clamp forceps.....	161
Buchwald , tongue depressors.....	86
Burners, alcohol.....	172
Burnishers.....	151-156-157
Burnishers, root.....	126

C

Calculus removers.....	110-114-123-127
Calibrated probes.....	106-107
Calipers.....	94-178
Cannula, suction.....	83
Carriers, amalgam.....	138-139
Cartridge syringes.....	93
Carvers for amalgam.....	151-155
Carvers for prosthodontia.....	181-184
Cases for instruments.....	92-128
Castroviejo , Calipers.....	94
Castroviejo , needle holders.....	87
Cement spatulas.....	158-159
Cheek retractors.....	84-86
Chisels.....	43-70-73
Chisels, enamel.....	130
Chompret , syndesmotomes.....	35
Clamp forceps.....	161
Clamps for rubber dam.....	161
Clasp bending pliers.....	192-202
Cleaners, tooth.....	110-114-123-127
Clips for towels.....	61
Cogswell , suction tubes.....	83
Cohen , tissue nippers.....	126
Coleman , root elevators.....	38
College , tweezers.....	98-100
Colour rings for curettes.....	116
Columbia , universal curettes.....	121
Composite carvers.....	149-151
Composite instrument e.....	149-151
Contouring pliers.....	207
Contra-angled filling instruments.....	140-143
Copper ring removing pliers.....	177
Cotton holders.....	92
Coupland , root elevators.....	33
Crane-Kaplan, pocket markers.....	59-127
Crane-Kaplan , scalars.....	112
Crile , needle holders.....	88
Crile-Ryder needle holders.....	89
Crile-Wood , needle holders.....	89
Pliers for prosthodontia and orthodontia.....	92-207
Crown removers.....	179-181
Crown scissors.....	176
Crown trial forceps.....	182

Cryer , extracting forceps.....	21-23
Cryer , root elevators.....	39
Cumine , scalars.....	111
Curettes, bone.....	62-64-69
Curettes, for root depressions.....	120
Curettes, for sinus lift.....	76
Curettes, Gracey.....	115-117-119-124
Curettes, Gracey Color.....	118
Curettes, miniatur.....	119
Curettes, „Quick-change.....	123-124
Curettes, surgical.....	69
Curettes, universal.....	121-122-124
Cushing , dissecting forceps.....	57
Cushing , tissue forceps.....	59
Cutters, wire.....	203
Cutting instruments.....	130

D

Darby-Perry , excavators.....	135
Dean , gum scissors.....	53
DeBakey , atraumatic forceps.....	57
DeBakey , needle holders.....	89
Decimal calipers.....	178
Denhart , mouth gags.....	86
Depressor, tongue.....	86
Diamond coated extracting forceps.....	13-16
Diamond coated tweezers.....	98-101
Discoid-cleoid , carving instruments.....	154
Dispensers.....	92
Dissecting forceps.....	56-57
Dissecting scissors.....	55
Doyen , needle holders.....	88
Doyen-Molt , mouth gags.....	86
Dressing forceps.....	61
Dycal , filling instruments.....	143

E

Economy , mouth mirror handle.....	96
Ehricke , Anatomic impression trays.....	185-188
Eiselsberg-Mathieu , needle holders.....	90
Elevators.....	29-42
Elevators, root fragment.....	42
Elevators, periosteal.....	65-68
Enamel chisels.....	130
Endodontic instruments.....	162-166
Epker , osteotomes.....	73
Ermert , wax knives.....	172
Excavators.....	132-136-162
Explorers.....	102-105
Explorers, root canal.....	105-162
Extracting forceps.....	5-23
Extracting forceps, american pattern.....	21-24
Extracting forceps, anatomic handle.....	13-16
Extracting forceps, diamond coated.....	13-16
Extracting forceps, english pattern.....	5-20
Extracting forceps for children.....	18-20-24

F

Fahnenstock , wax knife.....	173
Farabeuf , retractors.....	82
Fedi , periodontal chisels.....	71
Files, bone.....	69
Files, periodontal.....	126
Filling instruments.....	140-151
Filling instruments, composite.....	149-151
Filling instruments, root canal.....	163-165
Finger protectors.....	85
Fistula probes.....	80
Flagg , tweezers.....	101
Flat nose pliers.....	192-194
Flohr , root elevators.....	34
Foil scissors, ceramics.....	51-176
Forceps, articulating paper.....	178
Forceps, children.....	18-20-24
Forceps haemostatic.....	60
Forceps, clamp.....	161
Forceps, crown trial.....	182
Forceps, dissecting.....	56-57
Forceps, dressing.....	61
Forceps, extracting.....	5-24
Forceps, gum seizing.....	61
Forceps, punch.....	160
Forceps, rongeur.....	25-28
Forceps, root.....	8-12-14-16-17
Forceps, root fragment.....	17
Forceps, root pin.....	166
Forceps, silver points.....	99-166
Forceps, suture.....	57-91
Forceps, tissue.....	58-59
Fox , gum seizing forceps.....	59
Fox , periosteal elevators.....	67
Fragment ejectors.....	42
Fragment forceps.....	17
Frahm , carvers.....	155-170
Frames, rubber dam.....	160
Frazier , suction tubes.....	83
Freer , chisels.....	71
Freer periosteal elevators.....	66-68
Frevort , flat nose liers.....	194-207
Friedman , rongeur forceps.....	25
Furcation probes.....	106
Furrer , copper ring removing pliers.....	177

G

Gags, mouth.....	86
Geurtsen , composite carvers.....	149
Geurtsen-Günay , curettes for root depressions.....	120
Gillet , excavators.....	132
Gillies , retractors.....	81
Gillies, tissue forceps.....	58
Gingival cord packers.....	177
Gingival margin trimmers.....	130-131
Gingivectomy instruments.....	47-125-127

Gingivectomy set.....	127
Glick , root canal pluggers.....	165
Goldmann-Fox , gingivectomy set.....	127
Goldmann-Fox , gum scissors.....	49-52
Goldmann-Fox ,.....	114-122-125-127
Gordon , contouring pliers.....	207
Goslee , flat nose pliers.....	193
Gouges.....	72
Gracey , curettes.....	115-117-119-124
Gracey , curettes miniatur.....	119
Gracey Color , curettes.....	118
Gritman , plaster knives.....	174
Gross , dressing forceps.....	61
Gum nippers.....	126
Gum scissors.....	49-53
Gum seizing forceps.....	61
Guy , extracting forceps.....	5
Guy , filling instruments.....	145

H

Haemostatic forceps.....	60
Halsted-Mosquito , haemostatic forceps.....	60
Hammers.....	74-139-172
Handles, mouth mirror.....	96
Handles, perio instruments.....	123
Handles, scalpels.....	45-47
Harris , extracting forceps.....	22
Hartmann Baby-Mosquito ,.....	60
Hauer , calibrated probe.....	107
Heat transmitter.....	163
Heidbrink , root elevators.....	42
Heidemann , spatulas.....	148-150
Helfgen , impression trays for implantology.....	191
Hemingway , bone curettes.....	63
Hilger , retractor.....	85
Hirschfeld, files.....	126
Hoe , scalars.....	114-127
Holder for mini scalpel blades.....	45
Holder, needle.....	87-90
Holder, razor blade.....	45
Hollenback, carvers.....	152-168
Hollenback , filling instruments.....	145
Holst , explorer.....	102

Hopson , filling instruments.....	145
Horn mallets.....	172
How, ligature pliers.....	205
Hygienist , scalars.....	110-111-123
Hylin , carving instruments.....	169
Hylin , root elevators.....	33
Hylin-Le Cron , carving instruments.....	169

I

Ilic , tissue nippers.....	126
Impression trays.....	184

Impression trays for implantology.....	191
Impression trays, occlusal.....	190

Instrument trays.....	92-128
Instruments, band.....	206
Instruments, carving.....	151-155
Instruments, carving for prosthodontia.....	168-171
Instruments, ceramics.....	169
Instruments, composite.....	149-151
Instruments, filling.....	140-151
Instruments, gingivectomy.....	47-125-127
Instruments, ligature.....	204-205
Instruments, waxing-on technique.....	171
Ivory , Amalgam carriers.....	139
Ivory , matrix retainers.....	137

Ivory , post pullers.....	162-178
Ivory , punch forceps.....	160
Ivory , rubber dam clamps.....	161
Ivory , separators.....	137
Iwanson , decimal calibers.....	178

J

Jacobson , needle holders.....	88
Jacquette , scalars.....	112
Jarabak , wire bending pliers.....	197
Johnson , contouring pliers.....	207
Jones , towel clips.....	61
Joseph , gum scissors.....	53

K

Kelly , gum scissors.....	49-53
Kelly , haemostatic forceps.....	60
Kidney bowls.....	92
Kilner , retractors.....	81
Kirkland , gingivectomy knives.....	125
Klein , extracting forceps for children.....	20
Knives, gingivectomy.....	47-125-127
Knives, plaster.....	174
Knives, wax.....	172-173
Kocher , retractors.....	83
König , periosteal elevators.....	65
Kopp , root elevators.....	37
Kramer , surgical curettes.....	69
Kramer-Ne vins , periodontal chisels.....	71

L

La Grange , gum scissors.....	49-51
Laboratory pliers.....	192-207
Ladmore , filling instruments.....	144
Lamp, alcohol.....	172
Landgraf , tweezers.....	100
Langenbeck , finger protectors.....	85
Langenbeck , retractors.....	82
Langer , universal curettes.....	121
Le Cron , carvers.....	169

Lecluse , root elevators.....	40	Mini-Friedman , rongeur forceps.....	25	Periotomes.....	75	
Lessmann , wax knives.....	173	Minnesota , cheek and lip retractors.....	85	Perry , tweezers.....	100	
Lexer-Mini , osteotome.....	72	Mirrors and handles.....	96-97	Planator , filling instruments.....	143	
Lichtenberg-Ryder , needle holders.....	90	Mitchell , carving instruments.....	170	Plaster cutting pliers.....	174	
Lichtenstein , spatulas for impression materials.....	175	Mitchell , osteotrimmer.....	111	Plaster knives.....	174	
Lift-ex , crown removers.....	180	Modelling instruments.....	151-155	Plate scissors.....	176	
Ligature instruments.....	204-205	Modelling instruments for prosthodontia.....	168-171	Pliers, Adams clasp.....	201	
Ligature scissors.....	50-54	Molt , mouth gags.....	86	Pliers, arch forming.....	195	
Light-Wire, wire bending plier.....	197	Molt , periosteal elevators.....	67	Pliers arrowhead clasp bending and forming.....	201	
Lindo-Levien, root elevators.....	36	Morell , crown removers.....	179	Pliers, band removing.....	206	
Lip retractors.....	84-86	Morse , scalers.....	113	Pliers, bar bending.....	199	
Littauer , ligature scissors.....	54	Mortonson , filling instruments.....	145	Pliers, clasp bending.....	195-202	
Locklin , gum scissors.....	53	Mosquito , haemostatic forceps.....	60	Pliers, contouring.....	207	
London-College , tweezers.....	98-100	Mouth gags.....	86	Pliers, copper ring removing.....	177	
London-Hospital , root elevators.....	38	Mouth mirrors.....	97	Pliers, flat nose.....	192-194	
Lucas , bone curettes.....	64	Müller-Senn , retracors.....	81	Pliers, ligature.....	204-205	
Lucas , chisels and gouges.....	72	N			Pliers, plaster cutting.....	174
Luer , rongeur forceps.....	26	Nabers , periodontal probe.....	106	Pliers, prosthodontic and orthodontic.....	192-207	
Luer-Friedmann , rongeur forceps.....	26	Napkin holder.....	96	Pliers, round nose.....	196	
Luks , root canal pluggers.....	164	Needle case.....	91	Pliers, telescope crown.....	183	
Luniatschek , tampon applicators.....	80	Needle holders.....	87-90	Pliers, wire bending.....	192-202	
Luxator , root elevators.....	29-30	Needles, suture.....	91	Pliers, wire ligature.....	204-205	
M			Nippers, wire.....	203	Pluggers.....	140-146-149-151
Mallets, horn.....	172	Northbent , ligature scissors.....	54	Pluggers, root canal.....	164-165	
Mallets, plugging.....	139	Noyes , gum scissors.....	51	Plugging mallets.....	139	
Mallets, riveting.....	172	Nyström , matrix retainers.....	137	Pocket markers.....	59-127	
Mallets, surgical.....	74	Nyström , carvers.....	153-168	Post pullers.....	162-178	
Markers for pockets.....	59-127	O			Pott , root elevators.....	41
Martini , bone curettes.....	62	Obwegeser , periosteal elevators.....	65	Prichard , periosteal elevators.....	68	
Mathieu , needle holders.....	90	Occlusal impression trays.....	190	Probes, fistula.....	80	
Mathieu-Eiselsberg , needle holders.....	90	Ochsenbein , periodontal chisels.....	70	Probes, periodontal.....	106-107	
Matrix retainers and matrixes.....	137	Oliver-Jones , band removing pliers.....	206	Protector, finger.....	85	
Maty , vestibulum retractor.....	84	Optiflex , explorers.....	104-105	Protector , instrument trays.....	128	
Mayo-Hegar , needle holders.....	89	Orban , gingivectomy knives.....	125	Punch forceps.....	160	
McCall , scalers.....	113	Oringer , cheek and lip retractor.....	86	Q		
McCall , universal curettes.....	122-124	Osteotomes.....	72-73	Quick-Change , periodontal instruments.....	123-124	
McKellops , bar bending pliers.....	200	Osteotrimmer, Scaler.....	111	Quinby , gum scissors.....	52	
Mead , surgical mallets.....	74	P			R	
Measuring probes, pocket.....	106-107	P.K. Thomas , for waxing-on technique.....	171	Ramus retractors.....	83	
Medicine applicator.....	80	Packers, gingival cord.....	177	Raspatories.....	65-68	
Medium , explorers.....	105	Parallel blade scalpel handle.....	47	Razor blade holders.....	45	
Meriam , tweezers.....	101	Parmly , extracting forceps.....	21	Read , extracting forceps.....	7	
Mershon , band pushers.....	206	Partsch , chisels and gouges.....	72	Receivers, waste.....	92	
Methot , cotton holders.....	92	Partsch , periosteal elevators.....	66	Reeb , occlusal impression trays.....	190	
Methot , waste receivers.....	92	Perforators, rubberdam.....	160	Removers, blades.....	47	
Metzenbaum , dissecting scissors.....	55	Perigrip , Anatomic impression trays.....	184	Removers, crowns.....	179-181	
Micro , gum scissors.....	51	Periodontal chisels.....	70-71	Retainers, matrix.....	137	
Micro, mirrors.....	97	Periodontal files.....	126	Retractors.....	81-83	
Micro , needle holders.....	87-88	Periodontal knives.....	47-125-127	Reynold , contouring pliers.....	207	
Micro-Adson , dissecting forceps.....	56	Periodontal probes.....	106-107	Rhodes , periodontal chisel.....	83	
Micro-Adson , tissue forceps.....	58	Periosteal elevators.....	65-68	Rhodium , mouth mirrors.....	97	
Middeldorpf , cheek retractors.....	85				Riegner , carving instruments.....	170
Miller , articulating paper forceps.....	178				Riveting mallets.....	172
Miller-Colburn , bone files.....	69				Roller, retractors.....	81
Mini scalpel blades.....	45					

Romerowski , burnishers.....	157
Rongeur forceps.....	25-28
Root burnishers.....	126
Root canal instruments.....	162-166
Root elevators.....	29-42
Root extracting forceps.....	8-12-14-16-17
Root extracting forceps, diamond coated.....	4-16-17
Rotondo , excavators.....	132
Rotondo , filling instruments.....	140-141-143-147-148
Round nose pliers.....	196
Routurier , extracting forceps.....	11
Roux , cheek and lip retractors.....	85
Rubber dam instruments.....	160-161

S

Scalers.....	110-11-123-127
Scalpel blades and handles.....	45-47
Schäfer , combined wound and cheek retractor.....	82
Schluger , periodontal file.....	126
Schwarz , wire bending pliers.....	200
Scissors, crown and plate.....	176
Scissors, foil.....	51-176
Scissors, gum.....	49-53
Scissors, ligature.....	52-54
Scissors, surgical.....	55
Seldin , periosteal elevator.....	67
Seldin , root elevators.....	39
Semken , dissecting forceps.....	56
Semken , tissue forceps.....	58
Senn-Green , retractors.....	81
Senn-Müller , retractors.....	81
Separator.....	137
Sharp spoons.....	62-64

Silicon knife.....	170
Silver points instruments.....	149
Silver points forceps.....	99-166
Sinus lift currettes.....	76
Sinus lift elevators.....	78-79

Soldering tweezers.....	172
Spatulas, cement.....	158-159
Spatulas, filling material.....	141-151
Spatulas, impression material.....	175
Spatulas, plaster.....	175
Spatulas, tongue.....	86
Spencer , ligature scissors.....	54
Spina Nasalis , retractors.....	83
Spreaders, root canal.....	163
Spoons, sharp.....	62-64
Sternberg , cheek and lip retractors.....	85
Stevens , gum scissors.....	50
Stieglitz , root fragment forceps.....	17
Stoke , clamp forceps.....	161
Stolley , impression trays.....	190

Suction tubes.....	83
Sugarman , tissue nippers.....	126
Super-Cut , gum scissors.....	48-53
Surgical curettes.....	69
Surgical mallets.....	74
Surgical scissors.....	55
Suture forceps.....	57-93
Suture needles.....	93
Suture scissors.....	50-54
Syndesmotomes.....	35
Syringes.....	93

T

Tampon applicators.....	80
Tantal , composite instruments.....	149
Taylor , dissecting forceps.....	57
Taylor , scalars.....	112
Taylor , tissue forceps.....	59
TC dissecting forceps.....	56
TC scissors.....	50-52
Telescope crown pliers.....	183
Thomas P.K. , for waxing-on technique.....	171
Thorpe , scalars.....	110
Tissue forceps.....	58-59
Tissue nippers.....	126
Tofflemire , matrix retainers.....	137

Tomes , extracting forceps.....	24
Tongue depressors.....	86
Tönnis , needle holders.....	88

Towel clips.....	61
Towner , scalars.....	114
Trays for instruments.....	92-128
Treymann , crown removers.....	179
Tubes, suction.....	83
Tweezers.....	98-101
Tweezers, diamond coated.....	98-101
Tweezers, soldering.....	172

U

Offenorde , bone currettes.....	62
Universal crown removers.....	181
Universal currettes.....	121-122-124
Universal explorers.....	102-103
Universal extracting forceps.....	21-23-24
Universal gingival cord packer.....	177
Universal pliers for prosthodontia and orthodontia.....	202

V

Vestibulum retractors.....	84
Vignon , carvers.....	155
Volkman , bone currettes.....	62

W

WACD , carvers.....	154
Wagner , gum scissors.....	51
Waldsachs-Original , universal pliers.....	202
Ward , carvers.....	153-168
Ward, filling instruments.....	146
Warwick-James , root elevators.....	38
Waste receiver.....	92
Water syringe.....	93
Wax knives.....	172-173
Waxing-on technique.....	171
Weingart , ligature pliers.....	205
West , periosteal elevators.....	68
Westcott , burnishers.....	156
Weston , explorer.....	103
WHO , periodontal-probe.....	106
Wieder , tongue depressors.....	86
Wiland , carvers.....	152
Williams , filling instruemnts.....	146
Williams , periodontal probe.....	106
Williger , bone currettes.....	62
Williger , mallets.....	74
Williger , periosteal elevators.....	65
Winter , root elevators.....	40
Wire bending pliers.....	192-202
Wire cutters.....	203
Witzel , forceps for roots.....	17
Woodson , filling instruments.....	146

Y

Young , wire bending pliers.....	197
Younger-Good , universal currettes.....	122

Z

Zahle , carving instruments.....	169
---	-----